

Pioneer *sound.vision.soul*

PLASMA DISPLAY SYSTEM
SYSTEME D'ÉCRAN PLASMA
SISTEMA DE PANTALLA DE PLASMA

PDP-42A3HD
PDP-4214HD

Register Your Product at
www.pioneerelectronics.com (US)
www.pioneerelectronics.ca (Canada)

Operating Instructions
Mode d'emploi
Manual de instrucciones

DD **DOLBY**
DIGITAL

SRS **TruSurround XT**

HDMI
HIGH-DEFINITION MULTIMEDIA INTERFACE

IMPORTANT



The lightning flash with arrowhead symbol, within an equilateral triangle, is intended to alert the user to the presence of uninsulated "dangerous voltage" within the product's enclosure that may be of sufficient magnitude to constitute a risk of electric shock to persons.

CAUTION

**RISK OF ELECTRIC SHOCK
DO NOT OPEN**

CAUTION:
TO PREVENT THE RISK OF ELECTRIC SHOCK, DO NOT REMOVE COVER (OR BACK). NO USER-SERVICEABLE PARTS INSIDE. REFER SERVICING TO QUALIFIED SERVICE PERSONNEL.



The exclamation point within an equilateral triangle is intended to alert the user to the presence of important operating and maintenance (servicing) instructions in the literature accompanying the appliance.

IMPORTANT SAFETY INSTRUCTIONS

- 1) Read these instructions.
 - 2) Keep these instructions.
 - 3) Heed all warnings.
 - 4) Follow all instructions.
 - 5) Do not use this apparatus near water.
 - 6) Clean only with dry cloth.
 - 7) Do not block any ventilation openings. Install in accordance with the manufacturer's instructions.
 - 8) Do not install near any heat sources such as radiators, heat registers, stoves, or other apparatus (including amplifiers) that produce heat.
 - 9) Do not defeat the safety purpose of the polarized or grounding-type plug. A polarized plug has two blades with one wider than the other. A grounding type plug has two blades and a third grounding prong. The wide blade or the third prong are provided for your safety. If the provided plug does not fit into your outlet, consult an electrician for replacement of the obsolete outlet.
 - 10) Protect the power cord from being walked on or pinched particularly at plugs, convenience receptacles, and the point where they exit from the apparatus.
 - 11) Only use attachments/accessories specified by the manufacturer.
 - 12) Use only with the cart, stand, tripod, bracket, or table specified by the manufacturer, or sold with the apparatus. When a cart is used, use caution when moving the cart/apparatus combination to avoid injury from tip-over.
- 
- 13) Unplug this apparatus during lightning storms or when unused for long periods of time.
 - 14) Refer all servicing to qualified service personnel. Servicing is required when the apparatus has been damaged in any way, such as power-supply cord or plug is damaged, liquid has been spilled or objects have fallen into the apparatus, the apparatus has been exposed to rain or moisture, does not operate normally, or has been dropped.

Note to CATV system installer.

This reminder is provided to call the CATV system installer's attention to Article 820-40 of the NEC that provides guidelines for proper grounding and, in particular, specifies that the cable ground—shall be connected to the grounding system of the building, as close to the point of cable entry as practical.



WARNING: THE APPARATUS IS NOT WATER-PROOFS, TO PREVENT FIRE OR SHOCK HAZARD, DO NOT EXPOSE THIS APPLIANCE TO RAIN OR MOISTURE AND DO NOT PUT ANY WATER SOURCE NEAR THIS APPARATUS, SUCH AS VASE, FLOWER POT, COSMETICS CONTAINER AND MEDICINE BOTTLE ETC.

WARNING: Handling the cord on this product or cords associated with accessories sold with the product will expose you to lead, a chemical known to the State of California and other governmental entities to cause cancer and birth defects or other reproductive harm. ***Wash hands after handling.***

NOTE: This equipment has been tested and found to comply with the limits for a class B digital device, pursuant to Part 15 of the FCC Rules. These limits are designed to provide reasonable protection against harmful interference in a residential installation. This equipment generates, uses, and can radiate radio frequency energy and, if not installed and used in accordance with the instructions, may cause harmful interference to radio communications. However, there is no guarantee that interference will not occur in a particular installation. If this equipment does cause harmful interference to radio or television reception, which can be determined by turning the equipment off and on, the user is encouraged to try to correct the interference by one or more of the following measures:

- Reorient or relocate the receiving antenna.
- Increase the separation between the equipment and receiver.
- Connect the equipment into an outlet on a circuit different from that to which the receiver is connected.
- Consult the dealer or an experienced radio/TV technician for help.

Information to User

Alteration or modifications carried out without appropriate authorization may invalidate the user's right to operate the equipment.

[For Canadian model]

This Class B digital apparatus complies with Canadian ICES-003.

CAUTION:

This product satisfies FCC regulations when shielded cables and connectors are used to connect the unit to other equipment. To prevent electromagnetic interference with electric appliances such as radios and televisions, use shielded cables and connectors for connections.

IMPORTANT NOTICE: The serial number for this equipment is located on the rear panel. Please write this serial number on your enclosed warranty card and keep it in a secure area. This is for your security.

WARNING: Be sure to plug this equipment into a grounding-type AC outlet.

Contents

Thank you for buying this Pioneer product.

Please read through these operating instructions so you will know how to operate your model properly. After you have finished reading the instructions, put them away in a safe place for future reference.

In some countries or regions, the shape of the power plug and power outlet may sometimes differ from that shown in the explanatory drawings. However the method of connecting and operating the unit is the same.

01 Important User Guidance Information

02 Safety Precautions

03 Supplied Accessories

04 Part Names

Plasma Display	11
Remote control unit	13

05 Preparation

Installing the Plasma Display	15
Preventing the Plasma Display from Falling Over	15
Preparing the remote control unit	16
Inserting batteries	16
Cautions regarding batteries	16
Allowed operation range of the remote control unit	16
Cautions regarding the remote control unit	17
Cable connections for watching digital and/or conventional TV channels	17
Connecting to an Aerial	17
Connecting the power cord	18

06 Basic Operations

Turning the power on and off (Standby)	19
Watching TV channels	20
Selecting the analog and digital channels	20
Changing channels	20
Changing the volume and sound	21
Displaying Information	21
Setting MTS/SAP mode	22
Using the multiscreen functions	22

07 Menu Setup

Menu configuration	24
Menu operations	24

08 Tuner Setup

Setting up TV channels	25
Scanning Channels Automatically	25
Scanning Analog Channels Manually	25
Scanning Digital Channels Manually	26
Editing Channel List	26
Display the Channel List	27
Setting up the Parental Control	27
Activating the Parental Control	28

Setting the voluntary movie rating system (MPAA)	28
Setting the TV Ratings	29
Setting up the Canadian rating systems	29
Blocking No rating programs	30
Viewing Closed Caption Information	30
Setting the Current Date and Time	31

9 Adjustments and Settings

Sleep Timer	32
Picture adjustments	32
Selecting the Picture Mode	32
Customizing the Picture Settings	33
Using the Noise Reduction Feature	33
Setting the Color Temperature	34
Selecting the Sound Effect	34
Customizing the Sound Settings	35
Adjusting the Volume Automatically	35
Setting the Surround Sound	35
Setting up External Digital Sound	35
Changing the Screen Size	36
Viewing the Input Source	36
Setting for the language of on-screen display	36
Setting for the audio language of digital TV	37
Screen Saver	37
Setting the Full White mode	37
Power Control	38
Switching the Plasma Display Off Automatically	38
Setting the Plasma Display On Time	38
Setting the Plasma Display Off Time	38

10 Enjoying through External Equipment

Connecting to the External Input	39
Connecting to the Component Input	40
Connecting to the HDMI Input	41
Connecting to the Monitor Output	41
Connecting to the DIGITAL Audio Output	42

11 Appendix

Troubleshooting	43
Specifications	45

Important User Guidance Information

In order to obtain maximum enjoyment from this Pioneer PureVision PDP-42A3HD/PDP-4214HD Plasma Display System, please first read this information carefully.

With the Pioneer PureVision PDP-42A3HD/PDP-4214HD, you can be assured of a high quality Plasma Display System with long-life and high reliability. To achieve images of exceptional quality, this Pioneer Plasma Display System incorporates state-of-the-art design and construction, as well as very precise and highly advanced technology.

Over the course of its lifetime, the luminosity of the Pioneer PDP-42A3HD/PDP-4214HD Plasma Display System will diminish very slowly, such as with all phosphor-based screens (for example, a traditional tube-type television). To enjoy beautiful and bright images on your Pioneer Plasma Display System for many years to come, please carefully read and follow the usage guidelines below.

Usage guidelines

All phosphor-based screens (including conventional tube-type televisions) can be affected by displaying static images for a prolonged period. Plasma Display Systems are no exception to this rule. After-image and permanent effects on the screen can be avoided by taking some basic precautions. By following the recommendations listed below, you can ensure longer and satisfactory results from your plasma:

- Whenever possible, avoid frequently displaying the same image or virtually still moving pictures (e.g. closed-captioned images or video game images which have static portions).
- Avoid viewing the On Screen Display for extended periods, from a DVD player, VCR, and all other components.
- Do not leave the same picture freeze-framed or paused continuously over a long period of time, when using the still picture mode from a TV, VCR, DVD player or any other component.
- Images which have both very bright areas and very dark areas side by side should not be displayed for a prolonged period of time.
- When playing a game, the "GAME" mode setting within "AV Selection" is strongly recommended. However, please limit its use to less than 2 hours at a time.
- After playing a game, or any still image, it is best to view a normal moving picture in the "WIDE" or "FULL" screen setting for over 3 times longer than the previous still/moving image.
- After using the Plasma Display System, always switch the display to "STANDBY" mode.

Installation guidelines

The Pioneer PureVision PDP-42A3HD/PDP-4214HD Plasma Display System incorporates a very thin design. To ensure safety, please take the proper measures to mount or install the Plasma Display, in order to prevent the unit from tipping over in the event of vibration or accidental movement.

This product should be installed by using only parts and accessories designed by PIONEER. Use of accessories other than the PIONEER installation bracket may result in instability, and could cause injury. For custom installation, please consult the dealer where the unit was purchased. To ensure correct installation, experienced and qualified experts must install the unit. PIONEER will not be held responsible for accident or damage caused by the use of parts and accessories manufactured by other companies.

To avoid malfunction and overheating when installing, make sure that the vents on the main unit are not blocked. To ensure proper heat emission:

- Distance the unit slightly from other equipment, walls, etc. For the minimum space required around the unit, see page 14.
- Do not fit the unit inside narrow spaces where ventilation is poor.
- Do not cover with a cloth, etc.
- Clean the vents on the sides and rear of the unit to remove dust build-up by using a vacuum cleaner set to its lowest suction setting.
- Do not place the product on a carpet or blanket.
- Do not reverse the product.

Using the unit without proper ventilation may cause the internal temperature to rise, and could result in possible malfunction. When the surrounding or internal temperature exceeds a certain degree, the display will automatically power off in order to cool the internal electronics and prevent a hazardous occurrence.

Malfunction can be caused by many factors: inappropriate installation site, improper assembly/installation/mounting, improper operation of or modifications made to this product. However, PIONEER cannot be held responsible for accidents or malfunction caused by the above.

NOTE

The following are typical effects and characteristics of a phosphor-based matrix display and as such, are not covered by the manufacturer's limited warranties:

- Permanent residual images upon the phosphors of the panel.
- The existence of a minute number of inactive light cells.
- Panel generated sounds, examples: Fan motor noise, and electrical circuit humming / glass panel buzzing

CAUTION

PIONEER bears no responsibility for any damages arising from incorrect use of the product by you or other people, malfunctions when in use, other product related problems, and use of the product except in cases where the company must be liable.

Information of pixel defect

Plasma Display displays images consisting of hundreds of thousands of minute pixels (light emitting cells), and there is a possibility of inactive, flashing or continually illuminated pixels.

Infrared rays

The Plasma Display releases infrared rays because of its characteristics. Depending on how the Plasma Display is in use, the remote controls of nearby equipment may be adversely affected or wireless headphones using infrared rays are interfered by noise. If this is the case, place that equipment at a location where its remote control sensor is not affected.

Radio interference

While this product meets the required specifications, it emits a small amount of noise. If you place such equipment as an AM radio, personal computer, and VCR close to this product, that equipment may be interfered. If this happens, place that equipment far enough from this product.

Plasma Display driving sound

The screen of the Plasma Display is composed of extremely fine pixels and these pixels emit light according to received video signals. This principle may make you hear buzz sound electrical circuit humming from the Plasma Display.

Also note that the rotation speed of the cooling fan motor increases when the ambient temperature of the product becomes high.

You may hear the sound of the fan motor at that time.

Do not attach such items as labels and tape to the product

- This may result in the discoloration or scratch of the cabinet.

When not using the product for a long period of time

- If you do not use the product for a long period of time, the functions of the product may be adversely affected. Switch on and run the product occasionally.

Condensation

- Condensation may take place on the surface or inside of the product when the product is rapidly moved from a cold place to a warm place or just after a heater is switched on in winter morning, for example. When condensation takes place, do not switch on the product and wait until condensation disappears. Using the product with condensation may result in malfunction.

Cleaning the screen

- When cleaning the screen of this product, gently wipe it with a soft dry cloth; the supplied cleaning cloth or other similar cloths (e.g., cotton and flannel). If you use a hard cloth or rub the screen hard, the surface of the screen will be scratched.
- If you clean the surface of the screen with a wet cloth, water droplets on the surface may enter into the product, resulting in malfunction.

Cleaning the cabinet

- When cleaning the cabinet of this product, gently wipe it with a soft dry cloth; the supplied cleaning cloth or other similar cloths (e.g., cotton and flannel). If you use a hard cloth or rub the cabinet hard, the surface of the cabinet will be scratched.
- The cabinet of this product is mostly composed of plastic. Do not use chemicals such as benzine or thinner to clean the cabinet. Using these chemicals may result in quality deterioration or coating removal.
- Do not expose the product to volatile gas or fluid such as pesticide. Do not make the product contact with rubber or vinyl products for a long period of time. The effect of plasticizer in the plastic may result in quality deterioration or coating removal.
- If you clean the surface of the cabinet with a wet cloth, water droplets on the surface may enter into the product, resulting in malfunction.

Handles at the rear of the Plasma Display

- Do not remove the handles from the rear of the Plasma Display.
- When moving the Plasma Display, ask another person for help and use the handles attached to the rear of the Plasma Display. Do not move the Plasma Display by holding only a single handle. Use the handles as shown.
- Do not use the handles to hang the product when installing or carrying the product, for example. Do not use the handles for the purpose of preventing the product from tilting over.

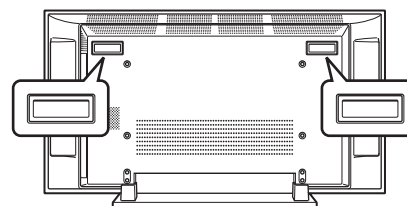

CAUTION

Panel sticking and after-image lag

- Displaying the same images such as still images for a long time may cause after-image lagging. This may occur in the following two cases.

1. After-image lagging due to remaining electric load

When image patterns with very high peak luminance are displayed more than 1 minute, after-image lagging may occur due to the remaining electric load. The after-images remaining on the screen will disappear when moving images are displayed. The time for the after-images to disappear depends on the luminance of the still images and the time they had been displayed.

2. After-image (lag image) due to burning

Avoid displaying the same image on the Plasma Display continuously over a long period of time. If the same image is displayed continuously for several hours, or for shorter periods of time over several days, a permanent after-image may remain on the screen due to burning of the fluorescent materials. Such images may become less noticeable if moving images are later displayed, but they will not disappear completely.

- The Auto Power Off function can be set to help prevent damage from screen burning (see page 38).

CAUTION

DO NOT PLACE THIS PRODUCT ON AN UNSTABLE CART, STAND, TRIPOD, BRACKET, OR TABLE. THE PRODUCT MAY FALL, CAUSING SERIOUS PERSONAL INJURY AND SERIOUS DAMAGE TO THE PRODUCT. USE ONLY WITH A CART, STAND, TRIPOD, BRACKET, OR TABLE RECOMMENDED BY THE MANUFACTURER, OR SOLD WITH THE PRODUCT. FOLLOW THE MANUFACTURE'S INSTRUCTIONS WHEN INSTALLING THE PRODUCT AND USE MOUNTING ACCESSORIES RECOMMENDED BY THE MANUFACTURER.

A PRODUCT AND CART COMBINATION SHOULD BE MOVED WITH THE CARE. QUICK STOPS, EXCESSIVE FORCE, AND UNEVEN SURFACES MAY CAUSE THE PRODUCT AND CART COMBINATION TO OVERTURN.



Electricity is used to perform many useful functions, but it can also cause personal injuries and property damage if improperly handled. This product has been engineered and manufactured with the highest priority on safety. However, improper use can result in electric shock and/or fire. In order to prevent potential danger, please observe the following instructions when installing, operating and cleaning the product. To ensure your safety and prolong the service life of your product, please read the following precautions carefully before using the product.

1. Read instructions—All operating instructions must be read and understood before the product is operated.
2. Keep this manual in a safe place—These safety and operating instructions must be kept in a safe place for future reference.
3. Observe warnings—All warnings on the product and in the instructions must be observed closely.
4. Follow instructions—All operating instructions must be followed.
5. Cleaning—Unplug the power cord from the AC outlet before cleaning the product. To clean the product, use the supplied cleaning cloth or other soft clothes (e.g., cotton, flannel).
6. Attachments—Do not use attachments not recommended by the manufacturer. Use of inadequate attachments can result in accidents.
7. Water and moisture—Do not use the product near water, such as bathtub, washbasin, kitchen sink and laundry tub, swimming pool and in a wet basement.
8. Stand—Do not place the product on an unstable cart, stand, tripod or table. Placing the product on an unstable base can cause the product to fall, resulting in serious personal injuries as well as damage to the product. Use only a cart, stand, tripod, bracket or table recommended by the manufacturer or sold with the product. When mounting the product on a wall, be sure to follow the manufacturer's instructions. Use only the mounting hardware recommended by the manufacturer.
9. When relocating the product placed on a cart, it must be moved with utmost care. Sudden stops, excessive force and uneven floor surface can cause the product to fall from the cart.



10. Ventilation—The vents and other openings in the cabinet are designed for ventilation. Do not cover or block these vents and openings since insufficient ventilation can cause overheating and/or shorten the life of the product. Do not place the product on a bed, sofa, rug or other similar surface, since they can block ventilation openings. This product is not designed for built-in installation; do not place the product in an enclosed place such as a bookcase or rack, unless proper ventilation is provided or the manufacturer's instructions are followed.
11. Power source—This product must operate on a power source specified on the specification label. If you are not sure of the type of power supply used in your home, consult your dealer or local power company.
12. Power cord protection—The power cords must be routed properly to prevent people from stepping on them or objects from resting on them. Check the cords at the plugs and product.

13. The plasma Display used in this product is made of glass. Therefore, it can break when the product is dropped or applied with impact. Be careful not to be injured by broken glass pieces in case the plasma Display breaks.
14. Overloading—Do not overload AC outlets or extension cords. Overloading can cause fire or electric shock.
15. Entering of objects and liquids—Never insert an object into the product through vents or openings. High voltage flows in the product, and inserting an object can cause electric shock and/or short internal parts. For the same reason, do not spill water or liquid on the product.
16. Servicing—Do not attempt to service the product yourself. Removing covers can expose you to high voltage and other dangerous conditions. Request a qualified service person to perform servicing.
17. Repair—If any of the following conditions occurs, unplug the power cord from the AC outlet, and request a qualified service person to perform repairs.
 - a. When the power cord or plug is damaged.
 - b. When a liquid was spilled on the product or when objects have fallen into the product.
 - c. When the product has been exposed to rain or water.
 - d. When the product does not operate properly as described in the operating instructions. Do not touch the controls other than those described in the operating instructions. Improper adjustment of controls not described in the instructions can cause damage, which often requires extensive adjustment work by a qualified technician.
 - e. When the product has been dropped or damaged.
 - f. When the product displays an abnormal condition. Any noticeable abnormality in the product indicates that the product needs servicing.
18. Replacement parts—In case the product needs replacement parts, make sure that the service person uses replacement parts specified by the manufacturer, or those with the same characteristics and performance as the original parts. Use of unauthorized parts can result in fire, electric shock and/or other danger.
19. Safety checks—Upon completion of service or repair work, request the service technician to perform safety checks to ensure that the product is in proper operating condition.
20. Wall or ceiling mounting—When mounting the product on a wall or ceiling, be sure to install the product according to the method recommended by the manufacturer.
21. Heat sources—Keep the product away from heat sources such as radiators, heaters, stoves and other heat-generating products (including amplifiers).
22. Unplug the power cord from the AC outlet before installing the speakers.
23. Never expose the screen of the Plasma Display to a strong impact, for example, by hitting it. The screen may be broken, resulting in fire or personal injury.
24. Do not expose the Plasma Display to direct sunlight for a long period of time. The optical characteristics of the front protection panel changes, resulting in discoloration or warp.
25. The Plasma Display weighs about 40.5 kg (89.3 lbs.) for the PDP-42A3HD/PDP-4214HD. Because it has small depth and is unstable, unpack, carry, and install the product with one more person at least and use the handles.

Installation Precautions

Observe the following precautions when installing with any items such as the optional brackets.

When using the optional brackets or equivalent items

- Ask your dealer to perform the installation.
- Be sure to use the supplied bolts.
- For details, see the instruction manual that comes with the optional brackets (or equivalent items).

Rear view

Mounting holes covered with rubber cap

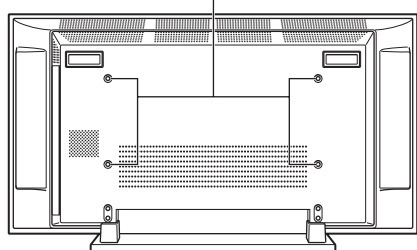

Side view

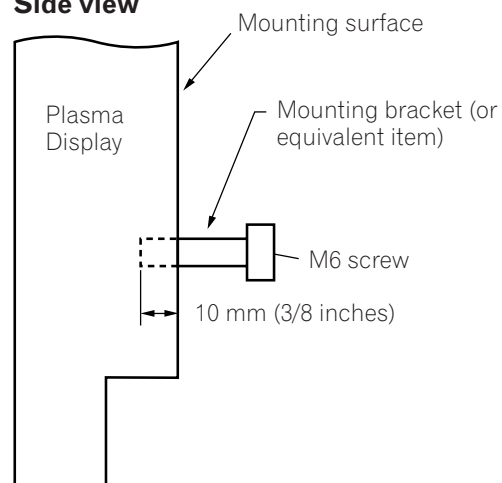

CAUTION

- Be sure to use four mounting holes covered with rubber cap.
- Use M6 screws, which go 10 mm (3/8 inches) in depth from the mounting surface of the Plasma Display. See the side view above.
- Be careful not to block the ventilation opening at the rear of the Plasma Display.
- Be sure to install the Plasma Display on a flat surface because it contains glass.
- The screw holes other than the above are to be used only for the specified products. Never use them for mounting non-specified products.

NOTE

- It is strongly recommended to use the optional PIONEER mounting products.
- PIONEER shall not be liable for any personal injury or product damage that results from the use of mounting items other than the optional PIONEER products.

03

Supplied Accessories

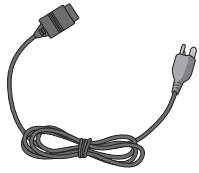

Power cord

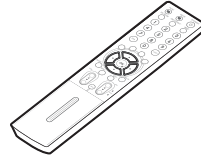

Remote control unit

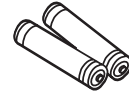

AAA size battery x 2
(Alkaline battery)

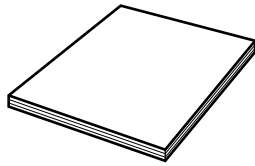

Operating Instructions

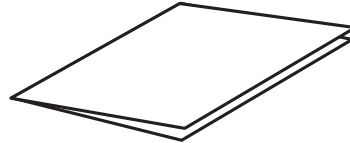

Warranty card



Hook x 2



NOTE

- Always use the power cord supplied with the Plasma Display.



Part Names

04

Plasma Display

Front view

English

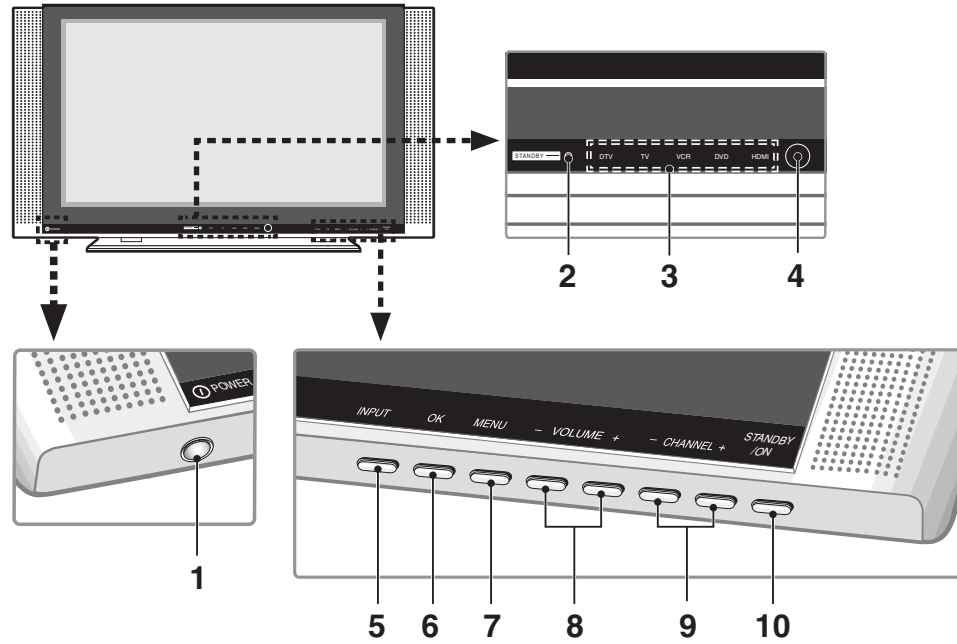

- | | |
|-----------------------------------|------------------------------|
| 1 POWER button | 6 OK button |
| 2 STANDBY indicator | 7 MENU button |
| 3 Current input source indicators | 8 VOLUME -/+ buttons |
| 4 Remote control sensor | 9 CHANNEL -/+ buttons |
| 5 INPUT button | 10 STANDBY/ON button |

Rear view

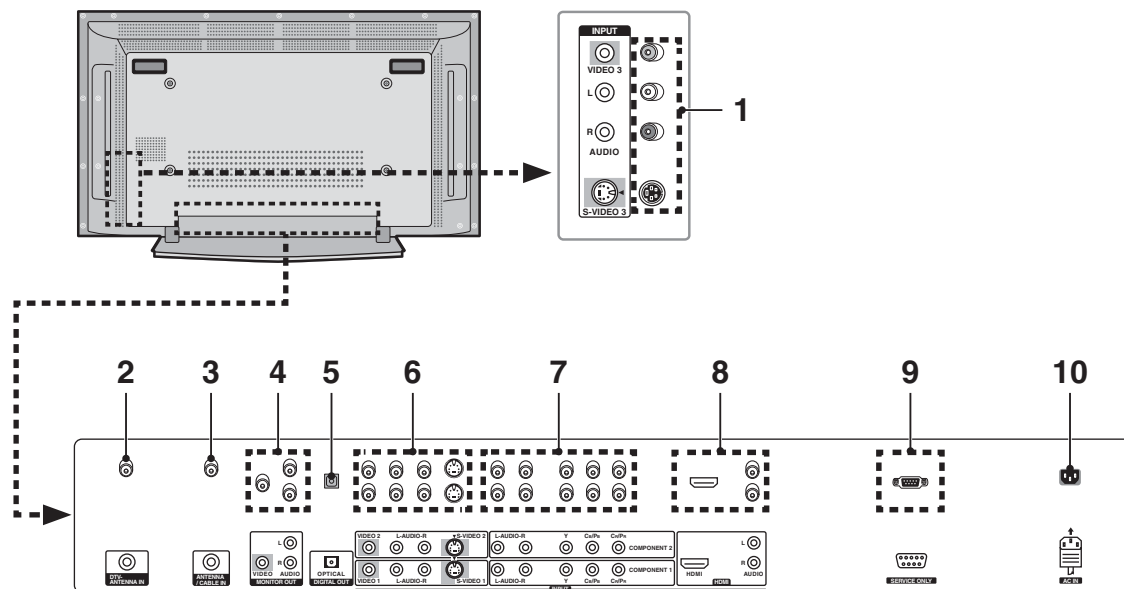

- 1 VIDEO 3 terminals (AUDIO/VIDEO/S-VIDEO)
- 2 DTV-ANTENNA IN terminal
- 3 ANTENNA/CABLE IN terminal
- 4 MONITOR OUT terminals (AUDIO/VIDEO)
- 5 DIGITAL OUT terminal
- 6 VIDEO 1/VIDEO 2 terminals (AUDIO/VIDEO/S-VIDEO)

- 7 COMPONENT 1/COMPONENT 2 terminals (COMPONENT VIDEO/AUDIO)
- 8 HDMI terminal (AUDIO/HDMI)
- 9 RS-232C terminal (service only)
- 10 AC IN terminal

Remote control unit

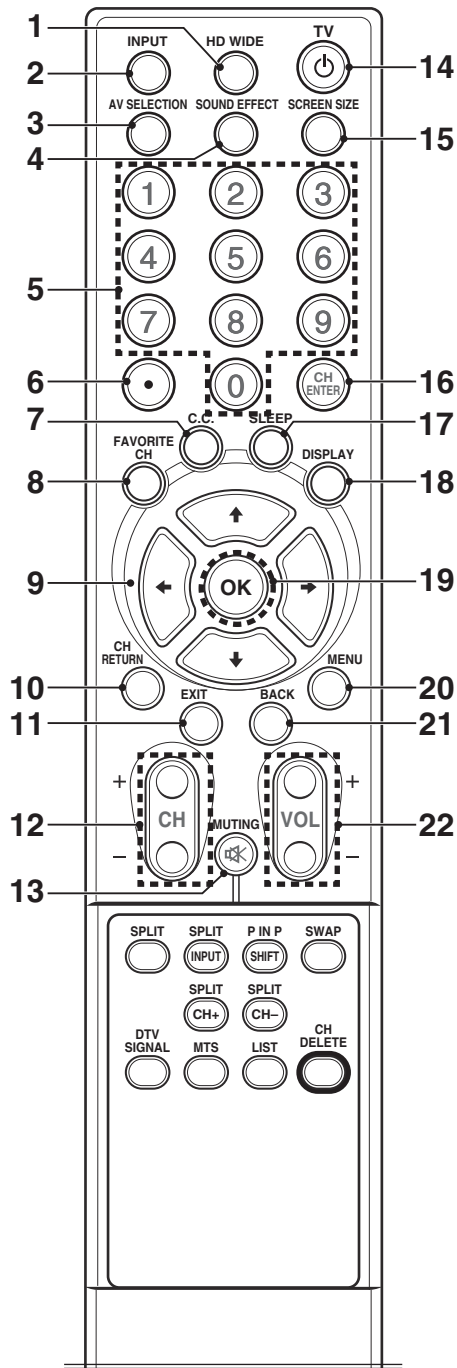

- 1 **HD WIDE:** Adjusts the picture to fit the 16:9 wide aspect ratio. Available in DTV mode.
- 2 **INPUT:** Displays all available input sources. Press the **↑** or **↓** button to select the required input source.
- 3 **AV SELECTION:** Selects the picture mode (Standard, Dynamic, Movie, Game or User).
- 4 **SOUND EFFECT:** Selects the sound effect (Flat, Speech, Movie, Music or User).
- 5 **0-9:** Select the channel.
- 6 **● (dot):** Selects the sub-channel of DTV.
- 7 **C.C.:** Display captions while in the closed-caption source.
- 8 **FAVORITE CH:** Selects the favorite channel.
- 9 **↑/↓/←/→:** Controls the cursor in the on-screen menu.
- 10 **CH RETURN:** Returns the selected channels.
- 11 **EXIT:** Exits from any display.
- 12 **CH +/-:** Changes the channel.
- 13 **MUTING:** Mutes the sound. To turn the sound back on, press the **MUTING**, **VOL +** or **VOL -** buttons.
- 14 **TV** : Switches between operation and standby mode.
- 15 **SCREEN SIZE:** Changes the aspect ratio of the screen (Zoom/Cinema/Full/4:3/Wide).
- 16 **CH ENTER:** Enters channels.
- 17 **SLEEP:** Sets the sleep timer.
- 18 **DISPLAY:** Shows the display.
- 19 **OK:** Executes a command.
- 20 **MENU:** Displays the on-screen menu.
- 21 **BACK:** Returns to the previous menu screen.
- 22 **VOL +/-:** Sets the volume.

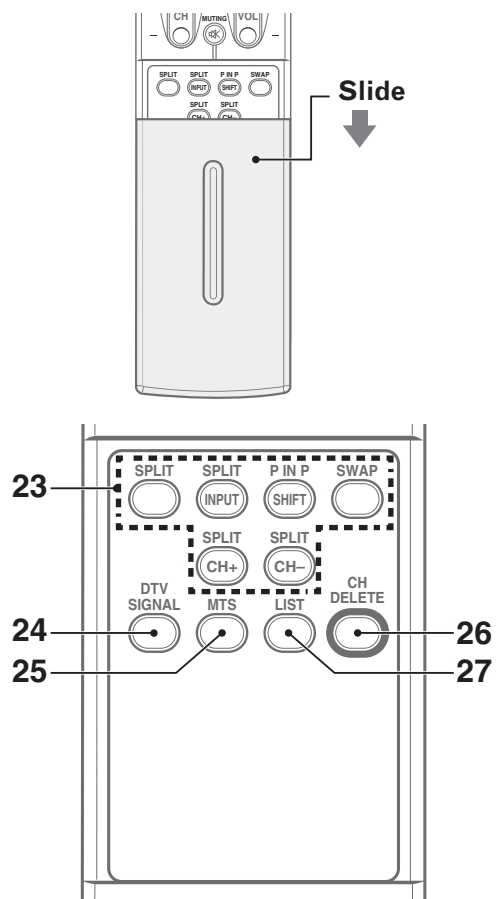

23 SPLIT Function Buttons

SPLIT: Selects the SPLIT mode (Off, PIP, Twin1 or Twin2).

SPLIT INPUT: Selects an input source for the sub picture.

P IN P/SHIFT: Selects a position for the sub-picture.

SWAP: Interchanges the main picture and sub-picture.

SPLIT CH + SPLIT CH -: Changes the channel of the sub-picture.

24 DTV SIGNAL: Displays the signal strength and quality.

25 MTS: Selects the sound mode.

26 CH DELETE: Deletes a channel.

27 LIST: Displays the channel list in Edit Channel List. Press the **↑** or **↓** button to select the required channel.



NOTE

- When using the remote control unit, point it at the Plasma Display.

Installing the Plasma Display

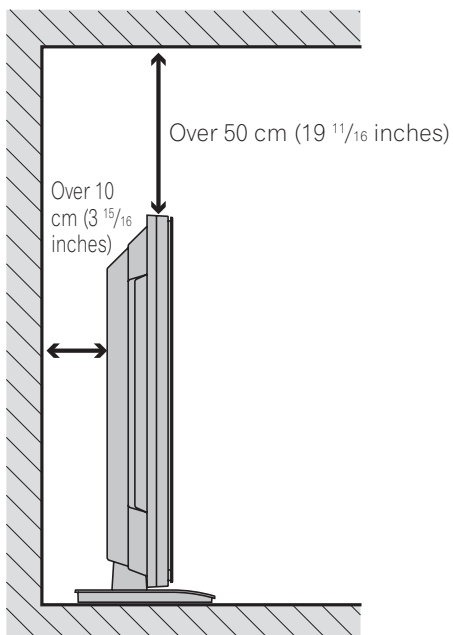

Locating

- Avoid direct sunlight. Maintain adequate ventilation.
- Because the Plasma Display is heavy, be sure to have someone help you when moving it.

CAUTION

- If you place anything on the top of the Plasma Display it will not receive enough ventilation and will not operate properly.

NOTE

- Allow enough space around the upper and back parts when installing to ensure ventilation around the backside.

CAUTION

Operating Environment

Operating environment temperature and humidity: +0°C to +40°C (+32°F to +104°F); less than 80% RH (cooling vents not blocked)

Avoid installing at the following locations:

- Under direct exposure to sunlight
- Under strong artificial light
- In high humidity
- Poorly ventilated

Preventing the Plasma Display from Falling Over

Be sure to take special care to ensure that the Plasma Display will not fall over.

Using a wall for stabilization

- 1 Attach the supplied falling prevention bolts (hooks) to the Plasma Display.
- 2 Use storing cords or chains to stabilize the Plasma Display appropriately and firmly to a wall, pillar, or other study element.
 - Perform this work in the same way for both the left and right sides.

NOTE

- Use ropes, chains and fittings that are available on the market.

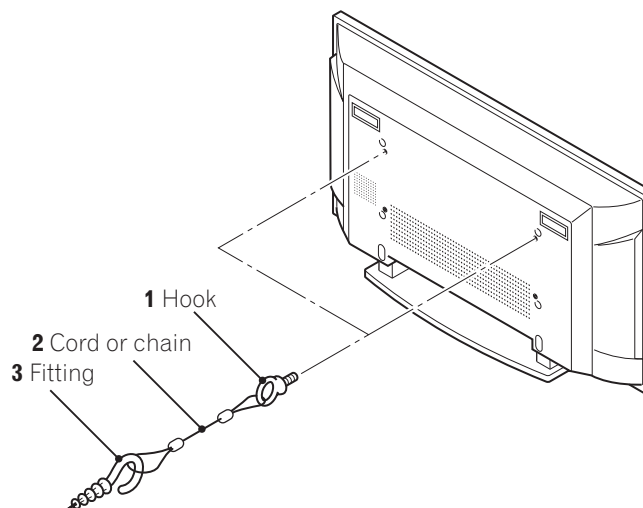

CAUTION

- A table or an area of the floor with adequate strength should always be used to support the Plasma Display. Failure to do so could result in personal injury and physical damage.
- When installing the Plasma Display, please take the necessary safety measures to prevent it from falling or overturning in case of emergencies, such as earthquakes, or of accidents.
- If you do not take these precautions, the Plasma Display could fall down and cause injury.
- The screws, hooks, chains and other fittings that you use to secure the Plasma Display to prevent it from overturning will vary according to the composition and thickness of the surface to which it will be attached.
- Select the appropriate screws, hooks, chains and other fittings after first inspecting the surface carefully to determine its thickness and composition and after consulting a professional installer if necessary.

Preparing the remote control unit

Inserting batteries

- 1 Open the battery cover.

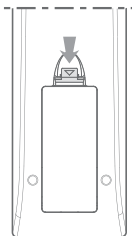

- 2 Insert the supplied two AAA (1.5 V) size batteries.

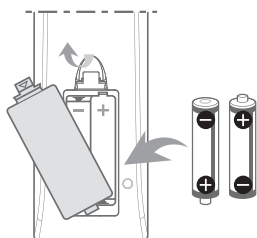

- The battery polarities must correspond with the (+) and (-) indicators in the battery compartment.

- 3 Close the battery cover.

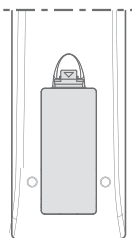

Cautions regarding batteries

- The remote control unit cannot operate the system if the batteries in the unit are empty. When this happens, replace the batteries with new ones.
- Do not use manganese batteries. When you replace the batteries, use alkaline ones.
- Do not mix batteries of different types. Different types of batteries have different characteristics.
- Do not mix old and new batteries. Mixing old and new batteries can shorten the life of new batteries or cause chemical leakage in old batteries.
- Do not leave dead batteries in the remote control unit; chemical leakage will occur. If you find any chemical leakage, wipe thoroughly with a cloth.
- The batteries supplied with this product may have a shorter life expectancy due to storage conditions.
- If you will not use the remote control unit for an extended period of time, remove the batteries from it.

CAUTION

- **WHEN DISPOSING OF USED BATTERIES, BE SURE TO COMPLY WITH GOVERNMENT REGULATIONS AND ENVIRONMENTAL PROTECTION GUIDELINES THAT APPLY IN YOUR COUNTRY OR AREA.**

Allowed operation range of the remote control unit

Operate the remote control unit while pointing it toward the remote control sensor located at the bottom center of the front panel of the Plasma Display. The distance from the remote control sensor must be within 7 m (23 feet) and the angle relative to the sensor must be within 30 degrees in the right or left direction.

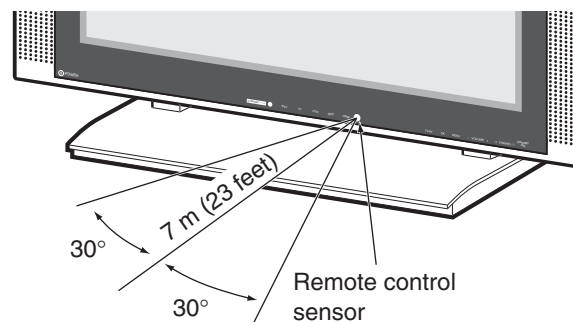

Cautions regarding the remote control unit

- Do not expose the remote control unit to shock, liquid, or high humidity.
- Do not place the remote control unit under direct sunlight; the unit may deform.
- The remote control unit may not work properly if the remote sensor window of the Plasma Display is under direct sunlight or strong lighting. In such case, change the angle of the lighting or Plasma Display, or operate the remote control unit closer to the remote sensor window.
- When any obstacle exists between the remote control unit and the remote control sensor, the remote control unit may not function.
- As the batteries become empty, the remote control unit can function within a shorter distance from the remote control sensor. Replace the batteries with new ones if necessary.
- The Plasma Display emits very weak infrared rays from its screen. If you place such equipment operated through infrared remote control as a VCR nearby, that equipment may not receive commands from its remote control unit properly or entirely. If this is the case, place that equipment at a location far enough from the Plasma Display.
- Depending on the installation environment, infrared rays from the Plasma Display may not allow this system to properly receive commands from the remote control unit or may shorten allowable distances between the remote control unit and the remote control sensor. The strength of infrared rays emitted from the screen differs, depending on images displayed on the screen.

Cable connections for watching digital and/or conventional TV channels

This system is equipped with two terminals for inputting TV broadcasting signals: ANTENNA/CABLE IN and DTV-ANTENNA IN. The ANTENNA/CABLE IN terminal accepts conventional TV broadcasting signals. The DTV-ANTENNA IN terminal accepts digital TV broadcasting signals. When using a cable TV to watch conventional TV channels, connect to the ANTENNA/CABLE IN terminal as shown.

Connecting to an Aerial

To view TV channels correctly, the Plasma Display must receive a signal.

Connecting the aerial of digital TV

When you connect the aerial of digital TV, connect the outdoor aerial.

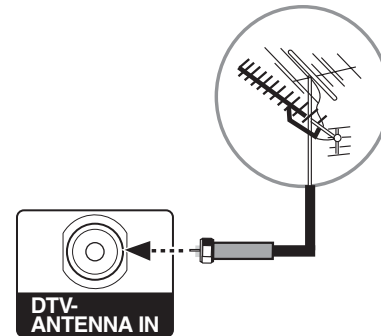

Connecting the aerial of analog TV

There are three ways to connect the aerial or network input cable for analog TV.

It is recommended to connect the outdoor aerial for the best outcome of the images.

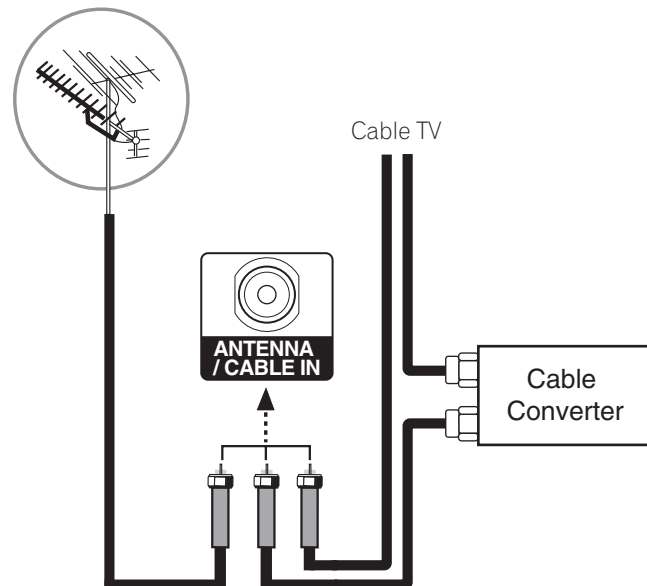

Connecting the power cord

Connect the power cord after all component connections are completed.

Plasma Display (rear view)

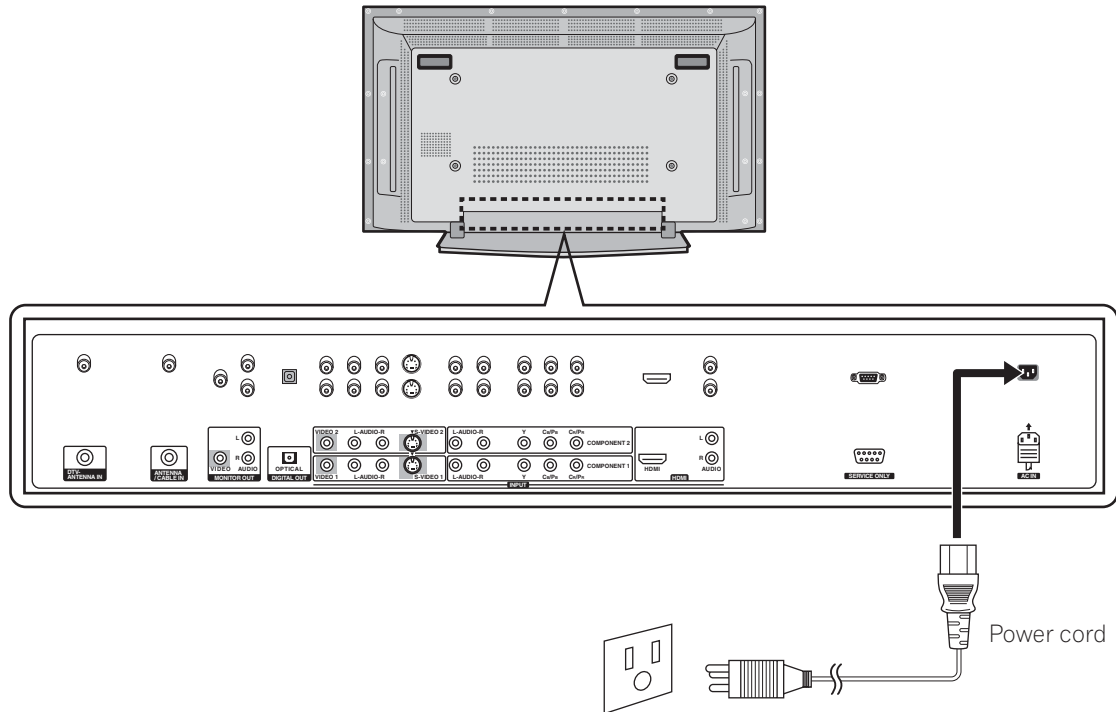

⚠ CAUTION

- Use only the supplied power cord.
- Be sure to use the specified power supply voltage; neglecting this can result in fire or electric shock.
- For the Plasma Display, a three-core power cord with a ground terminal is used for efficiency protection. Always connect the power cord to a three-pronged outlet and make sure that the cord is properly grounded.

📌 NOTE

- Always turn off the power of the Plasma Display when connecting the power cord.
- Disconnect the power cord from the power outlet when the Plasma Display is not going to be used for a long period of time.



Basic Operations

06

Turning the power on and off (Standby)

- 1 Press the **POWER** button on the bottom of the Plasma Display to enter the standby mode.
 - The **STANDBY** indicator lights up.
- 2 Press the **TV** button on the remote control or the **STANDBY/ ON** button on the bottom of the Plasma Display.
 - The Plasma Display switches to on. The **STANDBY** indicator lights off and the current input source indicator lights up.
- 3 To switch the Plasma Display off, press the **TV** button on the remote control or the **STANDBY/ ON** button on the bottom of the Plasma Display.
 - The Plasma Display enters to standby mode and the **STANDBY** indicator lights up instead of the current input source indicator.
- 4 To switch the Plasma Display off completely, press the **POWER** button on the bottom of the Plasma Display.
 - The **STANDBY** indicator lights off.

NOTE

- If you are not going to use the Plasma Display for a long period of time, press **POWER** button on the bottom of the Plasma Display to switch the Plasma Display off completely and disconnect the power cord of the Plasma Display from a wall outlet.
- If the Plasma Display is switched off completely, you cannot turn the Plasma Display on by pressing the **TV** button on the remote control.
- If the Plasma Display is switched off completely, it cannot switch the Plasma Display on automatically by the "On Timer" setting.

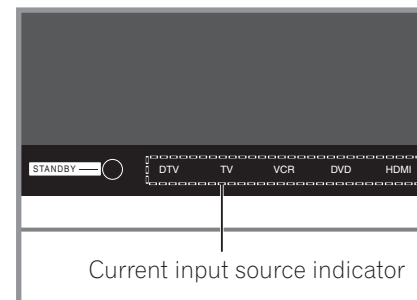
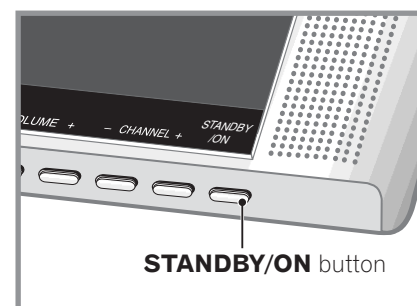
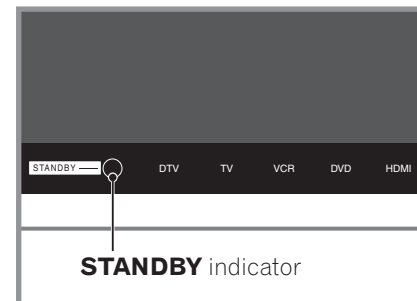
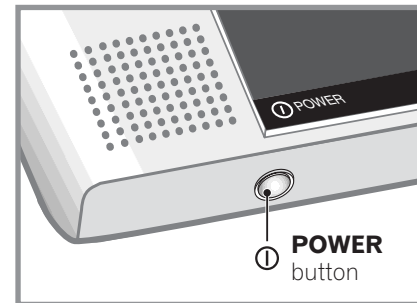

English

19

En

Watching TV channels

Unless you set up TV channels that you can watch under the current conditions, you cannot tune in those channels. For the procedure, see "Setting up TV channels" on page 25.

NOTE

- When watching a digital TV program, you may see emergency alert messages scrolling at the top of the screen. Those messages are broadcast by TV stations as necessary when in emergency situations.

Selecting the analog and digital channels

You can select the input mode between analog and digital channels by pressing the **INPUT** button.

NOTE

- When you switch the input mode, the last channel you previously selected will be received.

Changing channels

To increase the channel number, press the **CH +** button on the remote control unit. To decrease the channel number, press the **CH -** button.

- CHANNEL +/-** on the Plasma Display has the same function as **CH +/-** on the remote control unit.

Using 0 – 9 on the remote control unit

Select channels directly by pressing buttons **0** to **9**.

EXAMPLE

- To select channel 5 (1-digit channel), press **5**.
- To select channel 25 (2-digit channel), press **2** then **5**.
- To select channel 125 (3-digit channel), press **1**, **2**, then **5**.
- To select subchannel 10-01, press **1**, **0**, **.**(dot), **0**, then **1**.

NOTE

- Pressing the **CH ENTER** button after entering the channel number, enables you select channels quickly.
- To return to the previous channel, press the **CH RETURN** button.

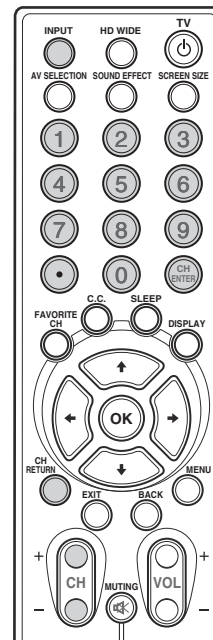

Changing the volume and sound

To increase the volume, press the **VOL +** button on the remote control unit. To decrease the volume, press the **VOL -** button.

- The **VOLUME +/-** buttons on the Plasma Display operates the same as the **VOL +/-** buttons on the remote control unit.
- To mute the sound output, press the **MUTING** button. "M" appears on the screen. To quit muting, press the **MUTING** button again. Pressing the **VOL +** button also quits muting.

Plasma Display

(bottom view)

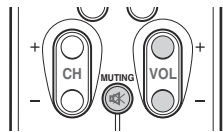
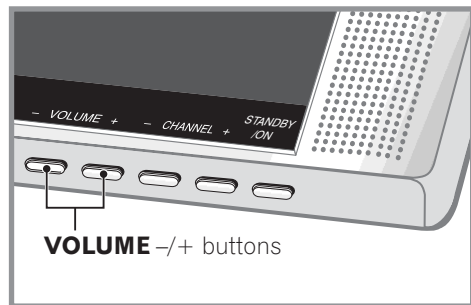

Volume adjustment



Muting



Displaying Information

You can display the channel information and setting status you selected.

Press the **DISPLAY** button.

For analog

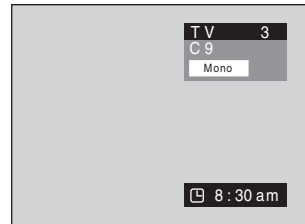

For SPLIT

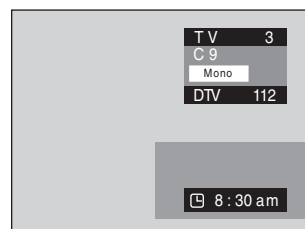

For external input

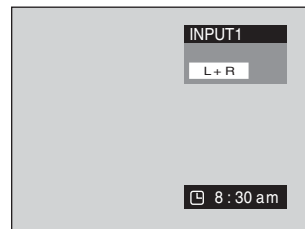

Press the **DISPLAY** button.

For digital



For SPLIT (digital reception)

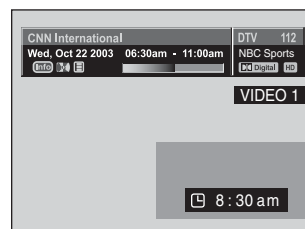

Setting MTS/SAP mode

When watching conventional TV programs, you may enjoy stereo sound and/or Secondary Audio Programs (SAP), using the Multi-channel Television Sound (MTS) function.

• Stereo broadcasts

You can enjoy, for example, sports, shows, and concerts in dynamic stereo sound.

• SAP broadcasts

MAIN sound: The normal program soundtrack (either in mono or stereo).

SAP sound: Listen to second language, supplementary commentary and other information. (SAP is mono sound.)

NOTE

- Conventional TV programs in this manual designate TV channels that are received through the conventional VHF/UHF frequencies or conventional cable TV channels.
- When stereo sound is difficult to hear, you can manually switch to the MONO mode to obtain clearer sound.
- Once the MONO mode is selected, the Plasma Display sound remains mono even if the Plasma Display receives a stereo broadcast. You must reselect the STEREO mode if you want to hear stereo sound again.
- Selecting MTS while the input source is in VIDEO, S-VIDEO, COMPONENT and HDMI does not change the type of the sound. In this case, the sound is determined by the video source.

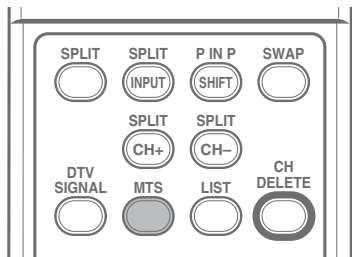

Each time you press the **MTS** button, MTS toggles as shown below.



NOTE

- In each of the MTS/SAP modes selected using the **MTS** button, the display changes depending on broadcasting signals being received.

Using the multiscreen functions

You can display a sub-picture within the main picture. In this way you can watch a TV program or monitor the video input from any connected device while watching TV or another video input.

Use this function following the procedures below to select the Twin (2-screen) or PIP (picture in picture) mode.

NOTE

- In the multiscreen function, the sound of a main input is always output.

PIP (picture in picture)

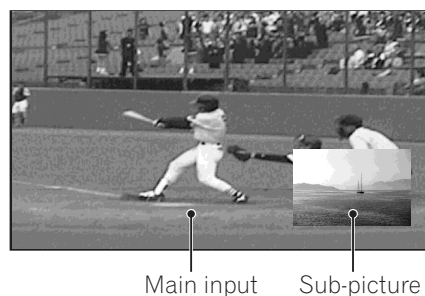

Twin 1 (2-screen)

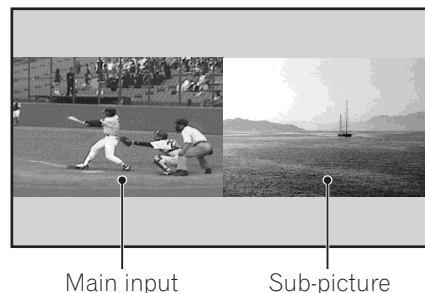

Twin 2 (2-screen)

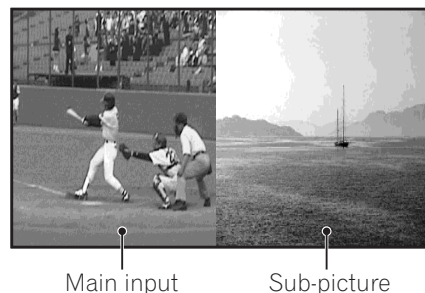

- 1 Press the **MENU** button.
- 2 Press the **↑** or **↓** button to move to **Screen**, then press the **→** or **OK** button.
- 3 Press the **↑** or **↓** button to move to **PIP/TWIN**, then press the **→** or **OK** button.

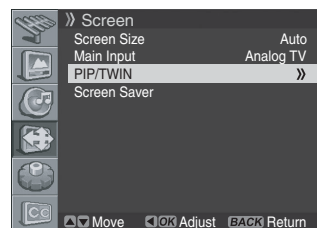

- Select **PIP/Twin Mode** and press the **➡** or **OK** button again.
- Press the **↑** or **↓** button to select the required option as follows, then press the **←** or the **BACK** button.
Off - PIP - Twin1 - Twin2

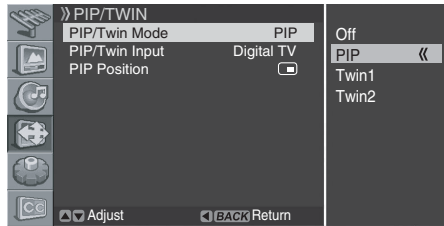

• If you set to **Off**, the following steps are not available.

- Press the **↑** or **↓** button to move to **PIP/Twin Input**, then press the **➡** or **OK** button.
- Press the **↑** or **↓** button to select the required input source as follows, then press **←** or the **BACK** button.
DIGITAL CH - ANALOG CH - VIDEO 1 - VIDEO 2 - VIDEO 3 - S-VIDEO 1 - S-VIDEO 2 - S-VIDEO 3 - COMPONENT 1 - COMPONENT 2 - HDMI

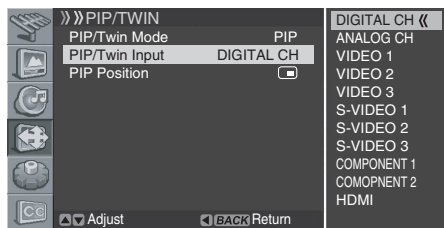

NOTE

- You can select the modes by simply pressing the **SPLIT** button on the remote control.
- You can select the sources by simply pressing the **SPLIT INPUT** button on the remote control.
- In Twin or PIP mode, press the **SWAP** button to switch the position of the 2- screen shown.

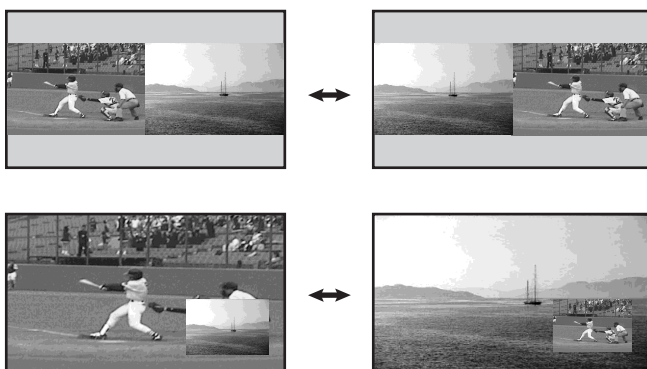

If you select "PIP" in the step 5

You can select the position of picture in picture display.

Press the **↑** or **↓** button to move to **PIP Position**, then press the **➡** or **OK** button.

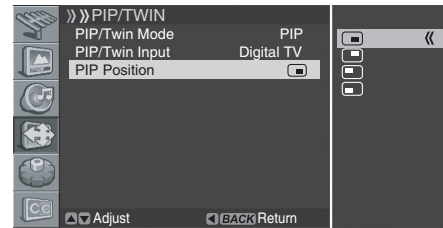

(Upper left)

(Upper right)

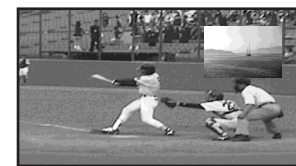
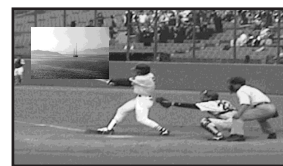

(Bottom left)

(Bottom right)

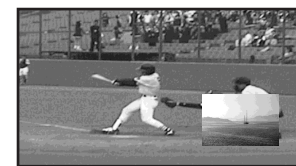
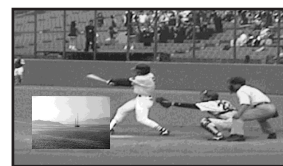

- You can select the positions by simply pressing the **SHIFT** button on the remote control.

- Press the **↑** or **↓** button to select the required position for the sub-picture, then press the **←** or **BACK** button.
- Press the **EXIT** button.

NOTE

- Multi screen function is available with the following combinations:
DIGITAL CH - ANALOG CH
DIGITAL CH/ANALOG CH - VIDEO1/2/3, S-VIDEO1/2/3,
COMPONENT1/2 or HDMI

Menu configuration

Home Menu	Item	Page
Tuner Setup	Scan Channels	25
	Scan Analog Channel	25
	Scan Digital Channel	26
	Edit Channel List	26

Picture	AV Selection	32
	Brightness	33
	Contrast	33
	Sharpness	33
	Color	33
	Tint	33
	Noise Reduction	33
	Color Temp	34

Sound	Effect	34
	Bass	35
	Treble	35
	Balance	35
	Auto Volume Level	35
	Surround	35
	Digital Audio Output	35

Screen	Screen Size	36
	Main Input	36
	PIP/TWIN	22, 23
	Screen Saver	37

System	Menu Language	36
	Audio Language	37
	Clock Setting	31
	Parental Control	27 - 30

Closed Caption	Display	30
	Analog CC	30
	DTV CC	30

Menu operations

The following describes the typical procedure for setting up the menus. For the actual procedures, see the appropriate pages that describe individual functions.

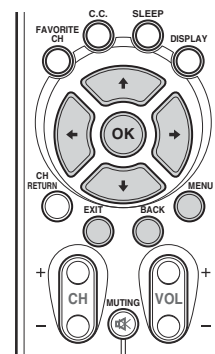

- 1 Press the **MENU** button.
- 2 Press **↑** or **↓** to select a menu item, and then press the **→** or **OK** button.
- 3 Repeat step 2 until you access the desired submenu item.
 - The number of menu layers differs depending on menu items.
- 4 Press **↑** or **↓** to select an option (or parameter), and then press the **→** or **OK** button.
 - For some menu items, press **←** or **→** instead of **↑** or **↓**.
- 5 Press the **EXIT** button to exit the menu.

NOTE

- You can return to the upper menu levels by pressing the **BACK** button.

Tuner Setup

Setting up TV channels

This section describes how to search and set up TV channels that you can watch under the current conditions. Unless you set up TV channels using Scan Channels, you may not be able to tune in any channels.

Scanning Channels Automatically

You can automatically scan channels for the frequency ranges available.

- 1 Press the **MENU** button.
- 2 Press the **↑** or **↓** button to move to **Tuner Setup**, then press the **→** or **OK** button.

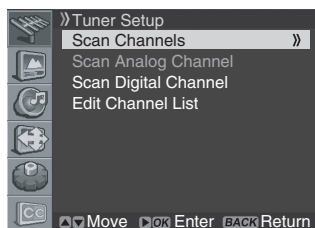

- 3 Select **Scan Channels** and press the **→** or **OK** button.
- 4 Select **Analog Channel Band** and press the **→** or **OK** button.
- 5 Press the **↑** or **↓** button to select the required signal source (**Air**, **STD**, **HRC** or **IRC**), then press the **←** or **BACK** button.
- 6 Move to **Start** by pressing the **↑** or **↓** button and start the search by pressing the **→** or **OK** button.

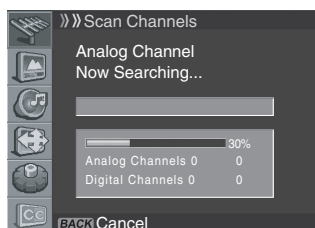

The scan start. The scanned channels are automatically stored in order. To stop scanning, press the **BACK** button.

- 7 When finished scanning, press the **EXIT** button.

NOTE

- When using the Cable Converter, you may need to manually add Cable Converter output channels.

Scanning Analog Channels Manually

You can choose if you want to store the channels.

- 1 Press the **MENU** button.
- 2 Press the **↑** or **↓** button to move to **Tuner Setup**, then press the **→** or **OK** button.

- 3 Press the **↑** or **↓** button to move to **Scan Analog Channel**, then press the **→** or **OK** button.

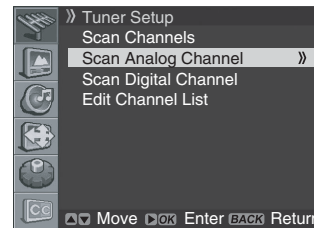

- 4 Press the **↑** or **↓** button to move to **Band**, then press the **→** or **OK** button.

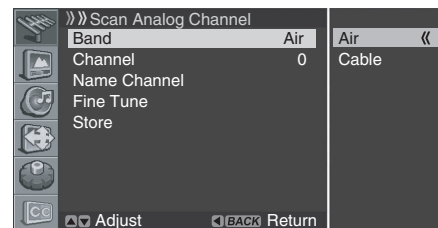

- 5 Press the **↑** or **↓** button to select the required signal source (**Air**, **STD**, **HRC** or **IRC**), then press the **←** or **BACK** button.

- 6 Move to **Channel** by pressing the **↑** or **↓** button and select the channel number by pressing the **←** or **→** button.

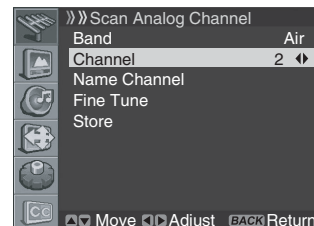

- 7 Press the **↑** or **↓** button to move to **Store** by pressing the **↑** or **↓** button, then press the **OK** button.

- You can receive the selected channel.

- 8 If you want to edit the channel name, press the **↑** or **↓** button to move to **Name Channel**, then press the **→** or **OK** button.

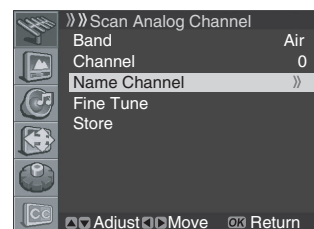

- 9 Press the **↑** or **↓** button to select a letter (A~Z, a~z), a number (0~9) or a symbol (space, { } ~ ! " # \$ % & () * + , - . / : ; < = > ? @ [\] ^ _ `). Move to the previous or next letter by pressing the **←** or **→** button.

- 10 When you have finished entering the channel name, press the **OK** button.

- 11 Press the **↑** or **↓** button to move to **Store** by pressing the **↑** or **↓** button, then press the **→** or **OK** button.

- 12 If you want to adjust the tuning, press the **↑** or **↓** button to move to **Fine Tune**, then press the **←** or **→** button to obtain good picture and sound quality.

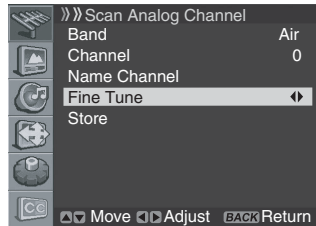

- 13 Press the **↑** or **↓** button to move to **Store**, then press the **OK** button.

- 14 Press the **EXIT** button.

NOTE

- "Scan Analog Channel" function is available only when the input source is set to "ANALOG CH". (See page 20.)
- You can also select the channel number by pressing the numeric buttons directly.

Scanning Digital Channels Manually

You can scan through the digital channels manually. The channel numbers are fixed according to the broadcasting stations.

- 1 Press the **MENU** button.
- 2 Press the **↑** or **↓** button to move to **Tuner Setup**, then press the **→** or **OK** button.
- 3 Press the **↑** or **↓** button to move to **Scan Digital Channel**, then press the **→** or **OK** button.
- 4 Press the **↑** or **↓** button to move to **Channel**.

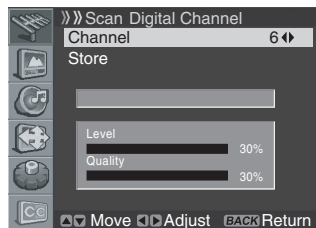

- 5 Press the **←** or **→** button to select the channel number which you want to scan. If the broadcasting station is scanned to the selected channel, a numerical value of "Level" and "Quality" will increase.
- 6 Press the **↑** or **↓** button to move to **Store**, then press the **←** or **→** button to start the search.

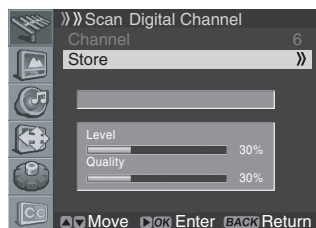

- 7 When finished scanning, press to **EXIT** button.

NOTE

- "Scan Digital Channel" function is available only the input source is set to "DIGITAL CH". (See page 20.)

Editing Channel List

- 1 Press the **MENU** button.
- 2 Press the **↑** or **↓** button to move to **Tuner Setup**, then press the **→** or **OK** button.
- 3 Press the **↑** or **↓** button to move to **Edit Channel List**, then press the **→** or **OK** button.

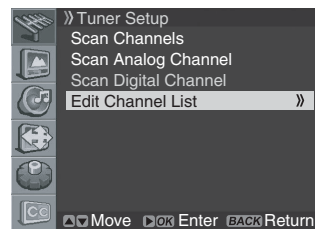

The channel list is displayed.

To delete a channel from the channel list, select the required channel by pressing the **↑** or **↓** button, then press the **CH DELETE** button twice. The channel is deleted.

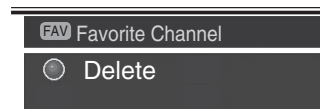

- 4 If you want to find channels quickly and easily when you watching TV, select the required channel by pressing the **↑** or **↓** button, then press the **FAVORITE CH** button. The selected channel is stored with "FAV" displayed. Press the **FAVORITE CH** button repeatedly to jump from one favorite channel to another.
- 5 Press the **EXIT** button.

NOTE

- Press the **CH** buttons to move to the next or previous page.
- The channel list displays the channels of those scanned by the scanning channel functions. If you want to cancel the Favorite mode, press the **FAVORITE CH** button while "FAV" is displayed.

Display the Channel List

You can display a list of all channels.

- 1 Press the **LIST** button.
 - The channel list is displayed.

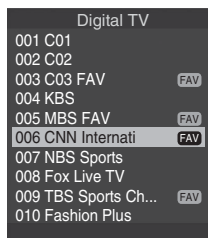

- 2 To tune to a specific channel in the channel list, move the cursor to the required channel by pressing the **↑** or **↓** button, then press the **OK** button.

NOTE

- Press the **CH** buttons to move to the next or previous page.

Setting up the Parental Control

This feature allows you to set a password to prevent unauthorized users, such as children, from watching unsuitable material. You can also set up the restrictions using Parental Guidance.

With the Parental Control parents can prevent their children from watching inappropriate TV programs, VCR or DVD contents. When an attempt is made to watch a program (or content) blocked by parents, the Plasma Display shows nothing but a message. The Parental Control functions for both conventional and digital TV channels.

Voluntary movie rating system (MPAA)

Rating	Description
G	General audiences. All ages admitted.
PG	Parental guidance suggested. Some material may not be suitable for children.
PG-13	Parents strongly cautioned. Some material may be inappropriate for children under 13.
Age-Base R	Restricted. Under 17 requires accompanying parent or adult guardian (age varies in some jurisdictions).
NC-17	No one 17 and under admitted.
X	A rating that has now been superseded by NC-17.
View	Not rated.

NOTE

- The voluntary movie rating system only uses an age-based rating.

TV Rating

Rating	Content						
	TV Rating-Children		TV Rating-General				
	Age	Fantasy violence	Age	Dialog (Sexually suggestive dialog)	Language (Adult language)	Sex (Sexual situations)	Violence
TV-Y (All children)	X						
TV-Y7 (Directed to older children)	X	X					
Age-Base TV-G (General audience)			X				
TV-PG (Parental guidance suggested)			X	X	X	X	X
TV-14 (Parents strongly cautioned)			X	X	X	X	X
TV-MA (Mature audience only)			X		X	X	X

X: Content rating can be set.

Activating the Parental Control

- 1 Press the **MENU** button.
- 2 Press the **↑** or **↓** button to move to **System**, then press the **→** or **OK** button.
- 3 Press the **↑** or **↓** button to move to **Parental Control**, then press the **→** or **OK** button.
Enter Password is displayed.

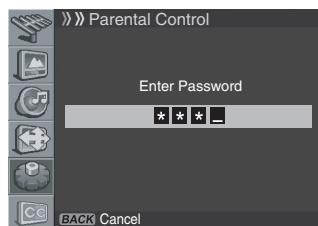
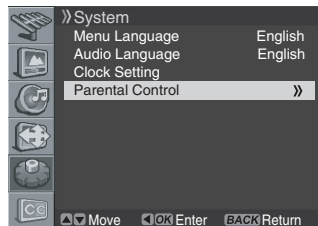

- 4 Enter your password by pressing the numeric buttons (0~9).

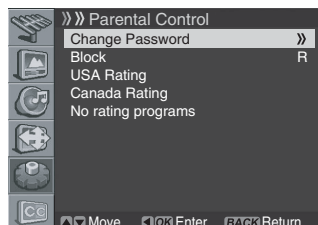

- 5 Press the **↑** or **↓** button to move to **Block**, then press the **→** or **OK** button.
- 6 Select the desired setting (**On** or **Off**).
- 7 Press the **EXIT** button.

Setting the voluntary movie rating system (MPAA)

- 1 Press the **MENU** button.
- 2 Press the **↑** or **↓** button to move to **System**, then press the **→** or **OK** button.

- 3 Press the **↑** or **↓** button to move to **Parental Control**, then press the **→** or **OK** button.
Enter Password is displayed.

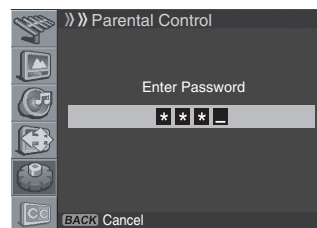

- 4 Enter your password by pressing the numeric buttons (0~9).

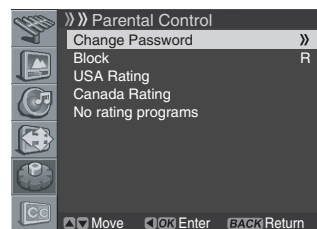

- 5 Select **Change Password** and press the **→** or **OK** button to change your password, if necessary.

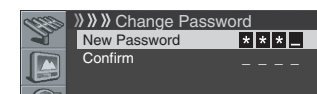

- 6 Enter your new password by pressing the numeric buttons (0~9), then re-enter to confirm.
 - The **Parental Control** menu is displayed again.

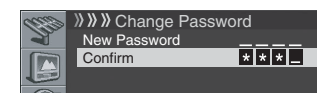

- 7 Press the **↑** or **↓** button to move to **USA Rating**, then press the **→** or **OK** button.
 - Select **MPAA Rating** and press the **→** or **OK** button again.

We suggest you write down your password so you do not forget it.

PDP-42A3HD/PDP-4214HD
Your password No.:

--	--	--	--

If you forget the password

When the on-screen menu is not displayed, press the **INPUT** button and then press "7", "2", "7" and "4" during the function selection screen is displayed. The password reverts to "0000".

- Press the **↑** or **↓** button to select the required rating as follows, then press the **←** or **BACK** button:
View - G - PG - PG-13 - R - NC-17 - X

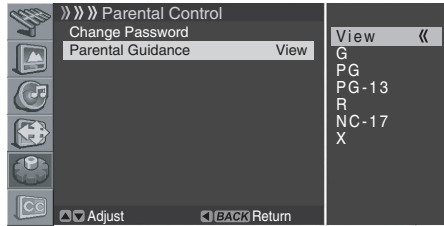

- The factory default is "View".

- Press the **EXIT** button.

NOTE

- The default password for a new Plasma Display is 0000.

Setting the TV Ratings

- Press the **MENU** button.
- Press the **↑** or **↓** button to move to **System**, then press the **→** or **OK** button.
- Press the **↑** or **↓** button to move to **Parental Control**, then press the **→** or **OK** button.
Enter Password is displayed.
- Enter your password by pressing the numeric buttons (0~9).
- Select **Change Password** and press the **→** or **OK** button to change your password, if necessary.
- Enter your new password by pressing the numeric buttons (0~9), then re-enter to confirm.
 - The **Parental Control** menu is displayed again.
- Press the **↑** or **↓** button to move to **USA Rating**, then press the **→** or **OK** button.
- Press the **↑** or **↓** button to select **TV Rating-Children** or **TV Rating-General**, then press the **→** or **OK** button.
- Press the **↑** or **↓** button to select the content as follows, then press the **→** or **OK** button.
TV Rating-Children: Age - Fantasy Violence
TV Rating-General: Age - Dialogue - Language - Sex - Violence
- Press the **↑** or **↓** button to select the required rating, then press the **←** or **BACK** button.
- Repeat steps 8 to 10, if necessary.
- Press the **EXIT** button.

NOTE

- The default password for a new Plasma Display is 0000.

Setting up the Canadian rating systems

- Press the **MENU** button.
- Press the **↑** or **↓** button to move to **System**, then press the **→** button or **OK** button.
- Press the **↑** or **↓** button to move to **Parental Control**, then press the **→** or **OK** button.
Enter Password is displayed.
- Enter your password by pressing the numeric buttons (0~9).

- Select **Change Password** and press the **→** or **OK** button to change your password, if necessary.
- Enter your new password by pressing the numeric buttons (0~9), then re-enter to confirm.
 - The **Parental Control** menu is displayed again.
- Press the **↑** or **↓** button to move to **Canada Rating**, then press the **→** or **OK** button.
 - Select **English Rating** or **French Rating** and press the **→** or **OK** button again.
- Press the **↑** or **↓** button to select the required rating as follows, then press the **←** or **BACK** button:
English Rating: C - C8+ - G - PG - 14+ - 18+ - View
French Rating: G - 8ans+ - 13ans+ - 16ans+ - 18ans+ - View
- Press the **EXIT** button.

NOTE

- The default password for a new Plasma Display is 0000.

Canadian rating systems

In Canada you can choose the Canadian English ratings or the Canadian French ratings. These ratings are based on the Canadian Radio-Television and Telecommunications Commission (CRTC) policy.

Canadian English ratings

Rating	Description
C	Children: Intended for younger children under the age of 8 years. Pays careful attention to themes that could threaten their sense of security and well-being.
C8+	Children over 8 years old: Contains no portrayal of violence as the preferred, acceptable, or only way to resolve conflict; nor encourage children to imitate dangerous acts which they may see on the screen.
G	General: Considered acceptable for all age groups. Appropriate viewing for the entire family, contains very little violence, physical, verbal or emotional.
Age-Base PG	Parental Guidance: Intended for a general audience, but may not be suitable for younger children (under the age of 8) because it could contain controversial themes or issues.
14+	Over 14 years: Could contain themes where violence is one of the dominant elements of the storyline, but it must be integral to the development of plot or character: Language usage could be profane and nudity present within the context of the theme.
18+	Adults: Intended for viewers 18 years and older and might contain depictions of violence, which while related to the development of plot, character or themes, are intended for adult viewing. Could contain graphic language and portrayals of sex and nudity.

Canadian French ratings

Rating	Description
G	General: All ages and children, contains minimal direct violence, but may be integrated into the plot in a humorous or unrealistic manner.
8ans+	General but inadvisable for young children: May be viewed by a wide public audience, but could contain scenes disturbing to children under eight who cannot distinguish between imaginary and real situations. Recommended for viewing with parent.
13ans+	Over 13 years: Could contain scenes of frequent violent scenes and therefore recommended for viewing with parent.
16ans+	Over 16 years: Could contain frequent violent scenes and intense violence.
18ans+	Over 18 years: Only for adult viewing. Could contain frequent violent scenes and extreme violence.

Age-Base

Blocking No rating programs

Use the following procedure to block TV programs whose rating information is unavailable.

- 1 Press the **MENU** button.
- 2 Press the **↑** or **↓** button to move to **System**, then press the **⇒** or **OK** button.
- 3 Press the **↑** or **↓** button to move to **Parental Control**, then press the **⇒** or **OK** button.
Enter Password is displayed.
- 4 Enter your password by pressing the numeric buttons (0~9).
- 5 Select **Change Password** and press the **⇒** or **OK** button to change your password, if necessary.
- 6 Enter your new password by pressing the numeric buttons (0~9), then re-enter to confirm.
 - The **Parental Control** menu is displayed again.
- 7 Press the **↑** or **↓** button to move to **No rating programs**, then press the **⇒** or **OK** button.
- 8 Press the **↑** or **↓** button to select the required option (**View** or **Block**), then press the **←** or **BACK** button.
- 9 Press the **EXIT** button.

NOTE

- The default password for a new Plasma Display is 0000.

Viewing Closed Caption Information

Your Plasma Display decodes and displays closed captions information that is broadcast along with some television shows. These captions are usually subtitles for the hearing impaired or in other languages. Look for the closed caption symbol **CC** in your TV guide.

- 1 Press the **MENU** button.
- 2 Press the **↑** or **↓** button to move to **Closed Caption**, then press the **⇒** or **OK** button.

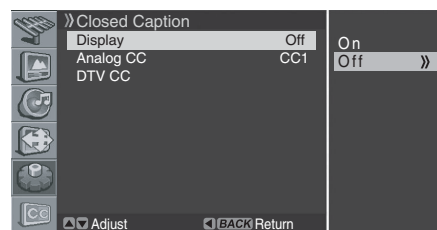

- 3 Press the **↑** or **↓** button to select **Display**, press the **⇒** or **OK** button and select the required option (**Off** or **On**), then press the **←** or **BACK** button.
- 4 To set up Closed Captions for analog channels, select **Analog CC** using the **↑** or **↓** buttons, then press the **⇒** or **OK** button.
- 5 Press the **↑** or **↓** button to select the required option as follows, then press the **←** or **BACK** button.
CC1 - CC2 - CC3 - CC4 - Text1 - Text2 - Text3 - Text4
 - The factory default is "CC1".
- 6 To set up Closed Captions for digital channels, select **DTV CC** using the **↑** or **↓** buttons, then press the **⇒** or **OK** button.
- 7 Press the **↑** or **↓** button to select the required option (Set by Program, Font Size, Foreground Color, Background Color or Digital Option), then press the **⇒** or **OK** button.
- 8 Select the required option for each item as follows, then press **←** or the **BACK** button:

Item	Selection
Set by Program	On/ Off
Font Size	Small/ Mid/ Large
Font Style	Default/ Courier/ Timers New Roman/ Helvetica/ Arial/ Dom/ Coronet/ Gothic/ Italic
Foreground Color	White/ Black/ Red/ Green/ Blue/ Yellow/ Magenta/ Cyan
Background Color	White/ Black/ Red/ Green/ Blue/ Yellow/ Magenta/ Cyan
Digital Option	Service1/ Service2/ Service3/ Service4/ Service5/ Service6

- 9 Press the **EXIT** button.

NOTE

- The options may change depending on the broadcasting service.
- You can select the options by simply pressing the **C.C.** button on the remote control.

Setting the Current Date and Time

You can set the current date and time so that the current time is displayed when pressing the **DISPLAY** button to display information.

- 1 Press the **MENU** button.
- 2 Press the **↑** or **↓** button to move to **System**, then press the **→** or **OK** button.

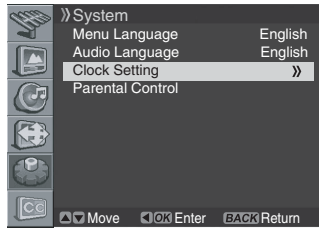

- 3 Press the **↑** or **↓** button to move to **Clock Setting**, then press the **→** or **OK** button again.

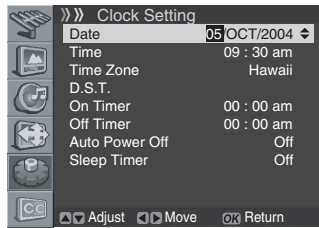

- 4 Select **Date** and press the **→** or **OK** button.
- 5 Press the **←** or **→** button to move to Day, Mon (month) and Year, then set them by pressing the **↑** or **↓** button.
- 6 When you have finished, press the **OK** button.
- 7 Press the **↑** or **↓** button to move to **Time**, then press the **→** or **OK** button.

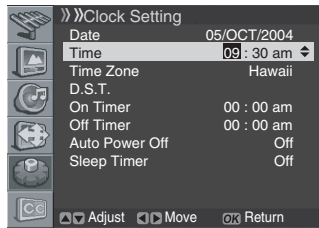

- 8 Press the **←** or **→** button to move to **Hour/Min**, set them by pressing the **↑** or **↓** button, then press the **OK** button.
- 9 If you receive a digital signal, you can set the time automatically. Press the **↑** or **↓** button to move to **Time Zone**, then press the **→** or **OK** button.
- 10 Press the **↑** or **↓** button to select the appropriate time zone for your local area as follows:
Hawaii – Alaska – Pacific – Mountain – Central – Eastern – Atlantic – Newfoundland

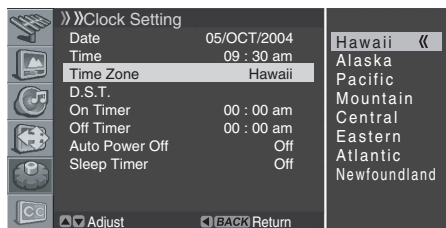

- 11 Press the **BACK** button.
- 12 Select **D.S.T.** and press the **→** or **OK** button.
- 13 Press the **↑** or **↓** button to select the required option as follows:
On – Off - Auto
- 14 Press the **EXIT** button.

NOTE

- **D.S.T.** stands for "Daylight Saving Time".
- When receiving a digital signal by successfully setting up a digital channel, the time and date are automatically updated.

Sleep Timer

You can select a time period of 10 to 240 minutes after which the Plasma Display automatically switches to standby mode.

- 1 Press the **MENU** button.
- 2 Press the **↑** or **↓** button to move to **System**, then press the **→** or **OK** button.

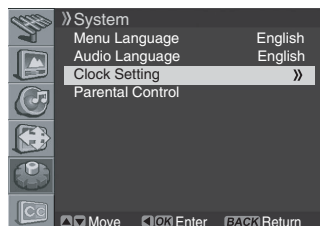

- 3 Select **Clock Setting** and press the **→** or **OK** button again.
- 4 Press the **↑** or **↓** button to move to **Sleep Timer**, then press the **→** or **OK** button.
- 5 Press the **↑** or **↓** button to select the preset time interval as follows:

Off - 10 min - 20 min - 30 min - 60 min - 120 min - 180 min - 240 min

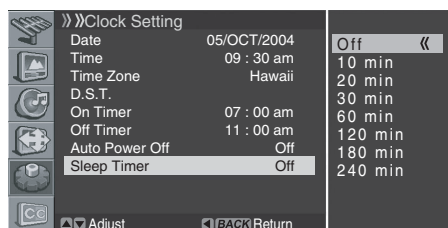

- 6 Press the **EXIT** button.

NOTE

- You can select the sleep time by simply pressing the **SLEEP** button on the remote control.

Picture adjustments

Selecting the Picture Mode

You can select the picture mode that corresponds to your viewing requirements best.

- 1 Press the **MENU** button.
- 2 Press the **↑** or **↓** button to move to **Picture**, then press the **→** or **OK** button.
- 3 Select **AV Selection** and press the **→** or **OK** button again.
- 4 Press the **↑** or **↓** button to select the required picture mode as follows:

Standard - Dynamic - Movie - Game - User

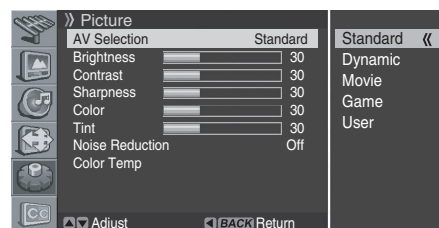

Item	Description
Standard (factory default)	For a highly defined image in a normally bright room
Dynamic	For a very sharp image with the maximum contrast
Movie	For a movie
Game	Lowers image brightness for easier viewing.
User	Allows the user to customize setting as desired. You can set the mode for each input source.

- 5 Press the **EXIT** button.

NOTE

- You can select the modes by simply pressing the **AV SELECTION** button on the remote control.

Customizing the Picture Settings

This Plasma Display has several setting options that allow you to control the picture quality.

- 1 Press the **MENU** button.
- 2 Press the **↑** or **↓** button to move to **Picture**, then press the **⇒** or **OK** button.
- 3 Press the **↑** or **↓** button to select the required option as follows, then press the **⇒** or **OK** button.

Brightness - Contrast - Sharpness - Color - Tint

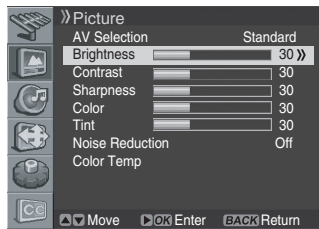

A horizontal bar is displayed. Press the **←** or **→** button until you reach the optimal setting.

To select other options, press the **↑** or **↓** button.

Item	← button	→ button
Brightness	For less brightness	For more brightness
Contrast	For less contrast	For more contrast
Sharpness	For less sharpness	For more sharpness
Color	For less color intensity	For more color intensity
Tint	Skin tones become purplish	Skin tones become greenish

- 4 Press the **BACK** or **MENU** button to return to the picture menu.
- 5 Press the **EXIT** button.

NOTE

- If you make any changes to the options, the picture mode is automatically switched to User.

Using the Noise Reduction Feature

- 1 Press the **MENU** button.
- 2 Press the **↑** or **↓** button to move to **Picture**, then press the **⇒** or **OK** button.
- 3 Press the **↑** or **↓** button to move to **Noise Reduction**, then press the **⇒** or **OK** button.
- 4 Press the **↑** or **↓** button to select the required option as follows:

Off - On

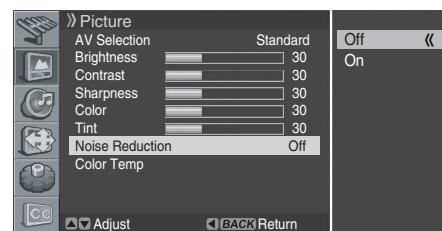

- The factory default is "Off".

- 5 Press the **EXIT** button.

NOTE

- If you make any changes to the options, "AV Selection" is automatically switched to "User".

Setting the Color Temperature

You can change tint of the screen to suit your requirements.

- 1 Press the **MENU** button.
- 2 Press the **↑** or **↓** button to move to **Picture**, then press the **→** or **OK** button.
- 3 Press the **↑** or **↓** button to move to **Color Temp**, then press the **→** or **OK** button.

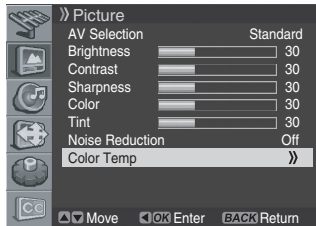

- 4 Press the **↑** or **↓** button to select the required option as follows, then press the **←** or **BACK** button.

High - Mid - Low

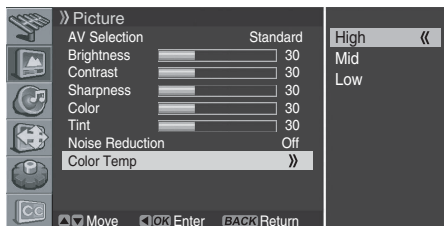

Item	Description
High	White with bluish tone
Mid (factory default)	Natural tone
Low	White with reddish tone

- 5 Press the **EXIT** button.

Selecting the Sound Effect

You can select the sound effect to be used.

- 1 Press the **MENU** button.
- 2 Press the **↑** or **↓** button to move to **Sound**, then press the **→** or **OK** button.
- 3 Select **Effect** and press the **→** or **OK** button again.
- 4 Press the **↑** or **↓** button to select the required sound effect as follows:

Flat - Speech - Movie - Music - User

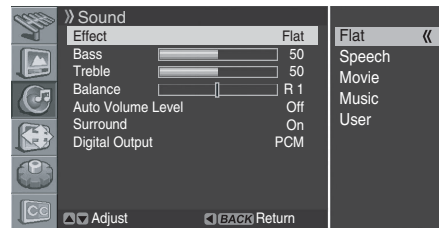

Item	Description
Flat (factory default)	Flat and pure sound.
Speech	Suitable for the programs with speech, such as News, etc.
Movie	You can enjoy sound effects like in a movie theater.
Music	Suitable for the music program.
User	Allows the user to customize the setting as desired.

- 5 Press the **EXIT** button.

NOTE

- You can select the modes by simply pressing the **SOUND EFFECT** button on the remote control.

Customizing the Sound Settings

This Plasma Display has several setting options that allow you to control the sound quality.

- 1 Press the **MENU** button.
- 2 Press the **↑** or **↓** button to move to **Sound**, then press the **→** or **OK** button.
- 3 Press the **↑** or **↓** button to select the required option (**Bass**, **Treble**, or **Balance**).
- 4 Press the **←** or **→** button until you reach the optimal setting.

Bass: 0~100

Treble: 0~100

Balance: L50~0~R50

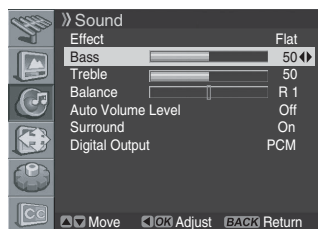

Item	← button	→ button
Bass	For weaker bass	For stronger bass
Treble	For weaker treble	For stronger treble
Balance	Decreases audio from the right speaker	Decrease audio from the left speaker

- 5 Press the **EXIT** button.

NOTE

- If you make any adjustment to the "**Bass**" or "**Treble**", the "**Effect**" is automatically switched to "**User**". Also, if you make any adjustment to the "**Balance**", the "**Effect**" is not switched.

Adjusting the Volume Automatically

This feature allows you to automatically adjust the volume of every channel by lowering the sound output when the modulation signal is high or by raising the sound output when the modulation signal is low.

- 1 Press the **MENU** button.
- 2 Press the **↑** or **↓** button to move to **Sound**, then press the **→** or **OK** button.
- 3 Select **Auto Volume Level** and press the **→** or **OK** button again.
- 4 Press the **↑** or **↓** button to select the required option (**On** or **Off**).

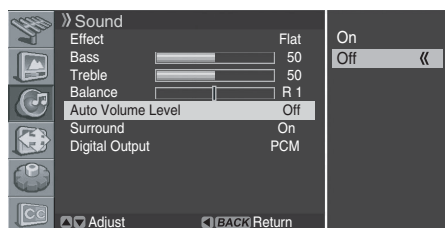

- The factory default is "**On**".

- 5 Press the **EXIT** button.

Setting the Surround Sound

You can enjoy the virtual surround sound effect.

- 1 Press the **MENU** button.
- 2 Press the **↑** or **↓** button to move to **Sound**, then press the **→** or **OK** button.
- 3 Press the **↑** or **↓** button to move to **Surround**, then press the **→** or **OK** button.
- 4 Press the **↑** or **↓** button to select the required option (**On** or **Off**).

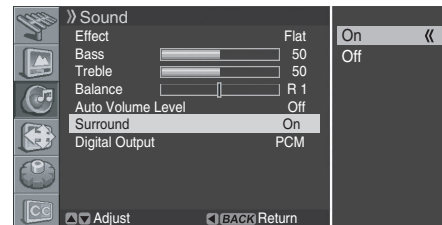

- The factory default is "**On**".

- 5 Press the **EXIT** button.

SRS is a trademark of SRS Labs, Inc. TruSurround XT technology is incorporated under license from SRS Labs, Inc.

NOTE

- If you switch the "**Surround**" setting, the sound type is automatically switched to "**User**".

Setting up External Digital Sound

You can enjoy the Dolby Digital* sound effect with the DIGITAL OUT connected to an external digital audio decoder.

- 1 Press the **MENU** button.
- 2 Press the **↑** or **↓** button to move to **Sound**, then press the **→** or **OK** button.
- 3 Press the **↑** or **↓** button to move to **Digital Audio Output**, then press the **→** or **OK** button.
- 4 Press the **↑** or **↓** button to select the required option (**PCM** or **Dolby Digital**).

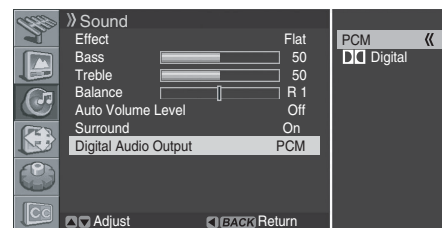

Item	Description
PCM (factory default)	Always the sound is output in the PCM format regardless of the types of signals.
Dolby Digital	For Dolby Digital encoded signals, the sound is output in the Dolby Digital format. For PCM encoded signals, the sound is output in the PCM format.

- 5 Press the **EXIT** button.

NOTE

- This setting is effective only for the signal of digital TV when you select DIGITAL CH.

* Dolby and the double-D symbol are registered trademarks of Dolby Laboratories.

Changing the Screen Size

You can change the aspect ratio of the screen to correspond to your viewing requirements.

- 1 Press the **MENU** button.
- 2 Press the **↑** or **↓** button to move to **Screen**, then press the **→** or **OK** button.
- 3 Select **Screen Size** and press the **→** or **OK** button again.
- 4 Press the **↑** or **↓** button to select the required aspect ratio as follows:

Zoom - Cinema - Full - 4:3 - Wide

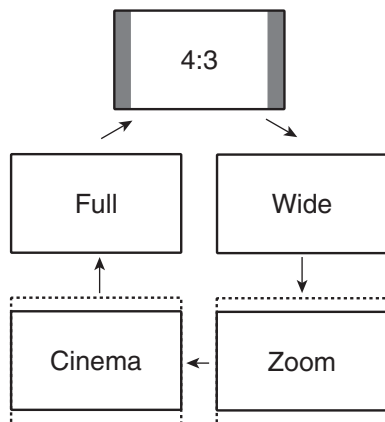
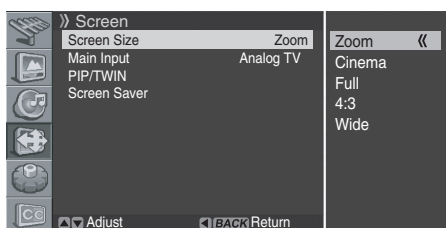

Item	Description
Zoom	For 16:9 letterbox pictures. Bars may appear on the top and bottom with some programs.
Cinema	For 14:9 letterbox pictures. Bars may appear on the top and bottom on some programs.
Full (factory default)	For 16:9 squeeze pictures.
4:3	For 4:3 "standard" pictures. A side bar appears on each side.
Wide	In this mode pictures are progressively stretched toward each side of the screen.

- 5 Press the **EXIT** button.

NOTE

- You can select the modes by simply pressing the **SCREEN SIZE** button on the remote control.
- If you watch High Definition TV broadcasting, you cannot select the screen mode. (The Screen Size setting is always set to "Full".)
- To enlarge 4:3 normal aspect ratio to 16:9 wide aspect ratio in DTV mode, press the **HD WIDE** button.

Viewing the Input Source

Once you have connected your audio and video systems, you can view different sources by selecting the corresponding input.

- 1 Press the **MENU** button.
- 2 Press the **↑** or **↓** button to move to **Screen**, then press the **→** or **OK** button.
- 3 Press the **↑** or **↓** button to move to **Main Input**, then press the **→** or **OK** button.
- 4 Press the **↑** or **↓** button to select the required input source as follows and press the **OK** button.

DIGITAL CH - ANALOG CH - VIDEO 1 - VIDEO 2 - VIDEO 3 - S-VIDEO 1 - S-VIDEO 2 - S-VIDEO 3 - COMPONENT 1 - COMPONENT 2 - HDMI

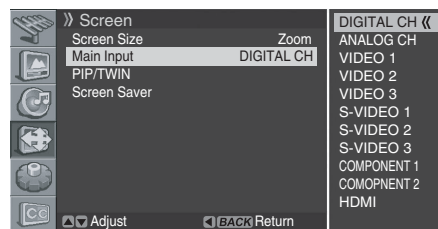

- The Plasma Display switches to selected source.

- 5 Press the **EXIT** button.

NOTE

- You can select the sources by simply pressing the **INPUT** button on the remote control.

Setting for the language of on-screen display

You can select a language to be used for on-screen display such as menus from among three languages: English, Spanish and French.

- 1 Press the **MENU** button.
- 2 Press the **↑** or **↓** button to move to **System**, then press the **→** button or **OK** button.
- 3 Press the **↑** or **↓** button to move to **Menu Language**, then press the **→** or **OK** button.
- 4 Press the **↑** or **↓** button to select the language (**English**, **Spanish** or **French**).

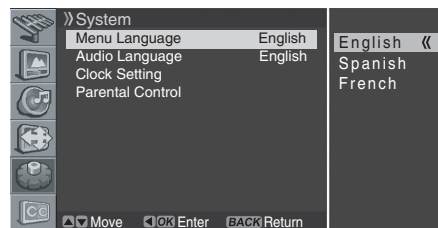

- The factory default is "English".

- 5 Press the **EXIT** button.

Setting for the audio language of digital TV

If you select a digital TV program that provides multi-language services, you can switch the language among followings: English, Spanish, French, German, Italian, Japanese and Korean.

- 1 Press the **MENU** button.
- 2 Press the **↑** or **↓** button to move to **System**, then press the **→** button or **OK** button.
- 3 Press the **↑** or **↓** button to move to **Audio Language**, then press the **→** or **OK** button.
- 4 Press the **↑** or **↓** to select the required language as follows:

English - Spanish - French - German - Italian - Japanese - Korean

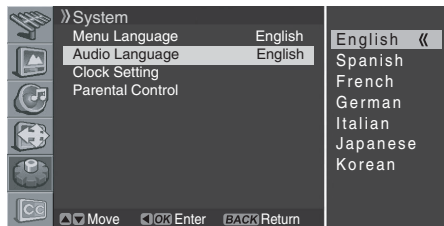

- The factory default is "English".

- 5 Press the **EXIT** button.

NOTE

- This setting affects only when the current broadcasting contains the selected language. When the broadcasting does not contain the selected language, it is output in English.

Screen Saver

You can prevent temporary or permanent screen burn caused by a still image.

- 1 Press the **MENU** button.
- 2 Press the **↑** or **↓** button to move to **Screen**, then press the **→** or **OK** button.

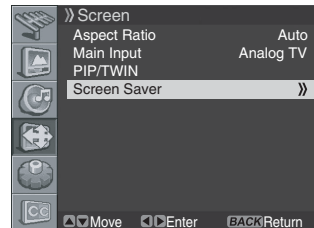

- 3 Press the **↑** or **↓** button to move to **Screen Saver**, then press the **→** or **OK** button.

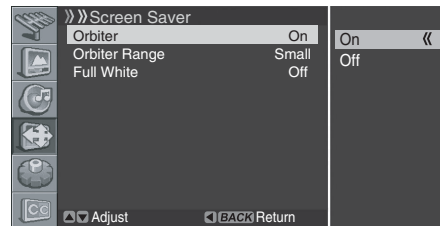

- 4 Select **Orbiter** and press the **→** or **OK** button again.
- 5 Press the **↑** or **↓** button to select the required option (**On** or **Off**), then press the **←** or **BACK** button.
- 6 Press the **↑** or **↓** button to move to **Orbiter Range**, then press the **→** or **OK** button.
- 7 Press the **↑** or **↓** button to select the required option as follows, then press the **←** or **BACK** button.

Small - Mid - Large

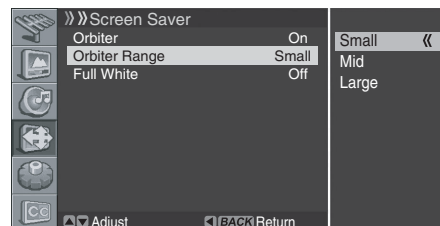

- The factory default is "Mid".

- 8 Press the **EXIT** button.

Setting the Full White mode

When displaying a still picture for a long time, it is recommended that you set "**Full White**" to "**On**" to reduce temporary or permanent screen burn.

- 1 Follow steps 1 to 3 in "**Screen Saver**".
- 2 Press the **↑** or **↓** button to move to **Full White**, then press the **→** or **OK** button.
- 3 Press the **↑** or **↓** button to select "**On**".

NOTE

- If you cancel the Full White mode, press the **EXIT** button. It is also canceled when 20 minutes elapse.

Power Control

Power Control provides convenient functions for power saving.

Switching the Plasma Display Off Automatically

- 1 Press the **MENU** button.
- 2 Press the **↑** or **↓** button to move to **System**, then press the **→** or **OK** button.

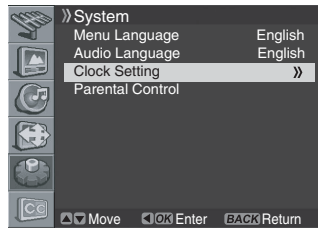

- 3 Select **Clock Setting** and press the **→** or **OK** button again.
- 4 Press the **↑** or **↓** button to move to **Auto Power Off**, then press the **→** or **OK** button.

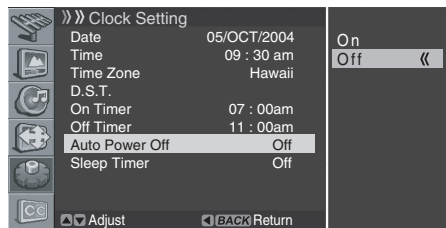

- 5 Press the **↑** or **↓** button to select the required option (**On** or **Off**).
 - The factory default is "On".
- 6 Press the **EXIT** button.

NOTE

- If "Auto Power Off" is set to "On", the Plasma Display automatically switches to standby mode when there is no input of a signal continues for 15 minutes.

Setting the Plasma Display On Time

You can set the on time so that the Plasma Display will switch on automatically at the time you select.

- 1 Press the **MENU** button.
- 2 Press the **↑** or **↓** button to move to **System**, then press the **→** or **OK** button.
- 3 Select **Clock Setting** and press the **→** or **OK** button again.
- 4 Move to **On Timer** by pressing the **↑** or **↓**, then press the **→** or **OK** button.

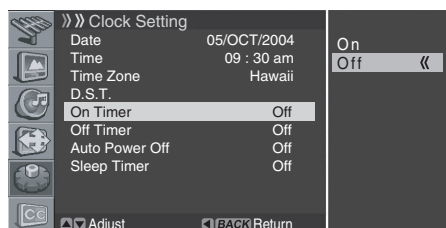

- 5 Press the **↑** or **↓** button to select **On**, then press the **←** or **BACK** button.
- 6 Press the **OK** button again. Press the **←** or **→** button to move to the hour and minute, set them by pressing the **↑** or **↓** button, then press the **OK** button.

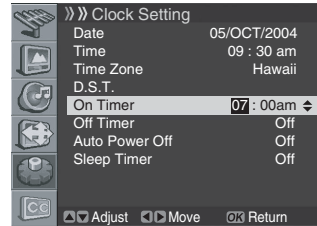

- 7 Press the **EXIT** button.

NOTE

- Once setting the specified time, turning On or Off if you **→** button is pressed, and changing the specified time if you pressed the **OK** button at step 4.

Setting the Plasma Display Off Time

You can set the off time so that the Plasma Display will switch off automatically at the time you select.

- 1 Press the **MENU** button.
- 2 Press the **↑** or **↓** button to move to **System**, then press the **→** or **OK** button.
- 3 Select **Clock Setting** and press the **→** or **OK** button again.
- 4 Move to **Off Timer** by pressing the **↑** or **↓** button, then press the **→** or **OK** button.

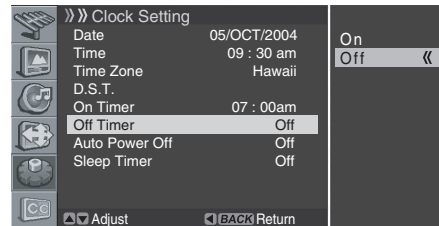

- 5 Press the **↑** or **↓** button to select **On**, then press the **←** or **BACK** button.
- 6 Press the **OK** button again. Press the **←** or **→** button to move to the hour and minute, set them by pressing the **↑** or **↓** button, then press the **OK** button.

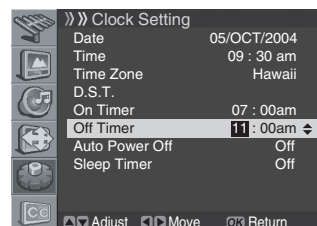

- 7 Press the **EXIT** button.

NOTE

- Once setting the specified time, turning On or Off if you **→** button is pressed, and changing the specified time if you pressed the **OK** button at step 4.



Enjoying through External Equipment

10

You can connect many types of external equipment to your Plasma Display, like a DVD player, VCR, game console, and camcorder.

CAUTION

- To protect all equipment, always turn off the Plasma Display before connecting to a DVD player, VCR, STB, or other external equipment.

NOTE

- Refer to the relevant instruction manual (STB, VCR, DVD player, etc.) carefully before making connections.

English

Connecting to the External Input

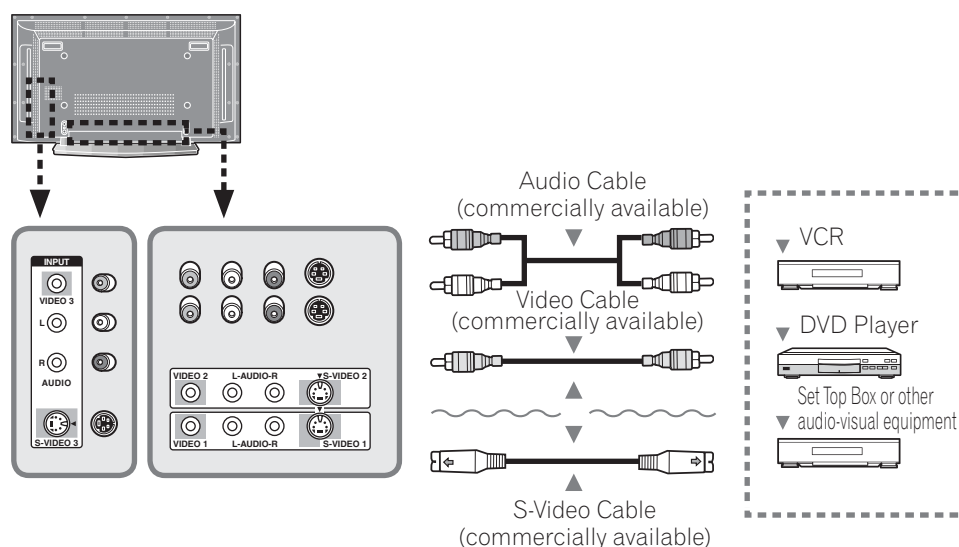

1

Connect the video cable to the **VIDEO (VIDEO 1, VIDEO 2 or VIDEO 3)** input jack on the Plasma Display and to the video output jack on the required equipment.

NOTE

- For equipment with an **S-VIDEO** jack, connect the S-Video cable between the **S-VIDEO (S-VIDEO 1, S-VIDEO 2 or S-VIDEO 3)** input jack on the Plasma Display and the S-Video output jack on the required equipment.

2 Connect the audio cable to the **AUDIO-L/R (VIDEO 1, VIDEO 2 or VIDEO 3)** input jack on the Plasma Display and to the audio output jack on the required equipment.

3 Turn the Plasma Display on, then press the **INPUT** button to select **VIDEO 1, VIDEO 2 or VIDEO 3**.

NOTE

- If you have connected the Plasma Display and the required equipment using an S-Video cable, select **S-VIDEO 1, S-VIDEO 2 or S-VIDEO 3**.

39

En

Connecting to the Component Input

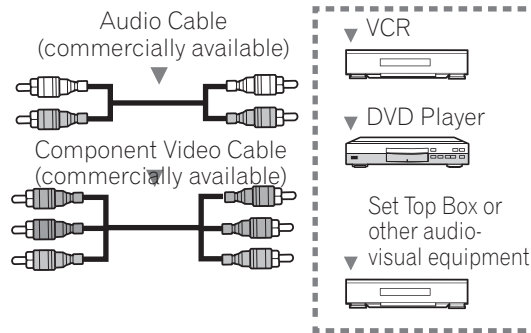
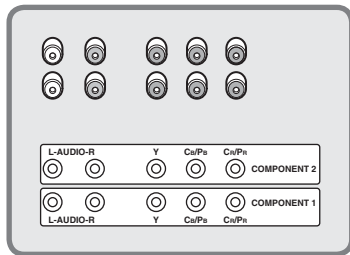
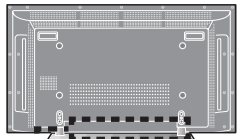

- 1 Connect the video cable to the **VIDEO-Y/Pb/Pr (COMPONENT 1 or COMPONENT 2)** input jacks on the Plasma Display and to the video output jacks on the required equipment.



NOTE

- Depending on the manufacturer, the **Y/Pb/Pr** jacks may be identified as **Y/PB/PR**, **Y/B-Y/R-Y**, or **Y/CB/CR**.
- Refer to your DVD player instruction manual for the signal type.

- 2 Connect the audio cable to the **AUDIO-L/R (COMPONENT 1 or COMPONENT 2)** input jacks on the Plasma Display and to the audio output jacks on the required equipment.
- 3 Turn the Plasma Display on, then press the **INPUT** button to select **COMPONENT 1** or **COMPONENT 2**.

Connecting to the HDMI Input

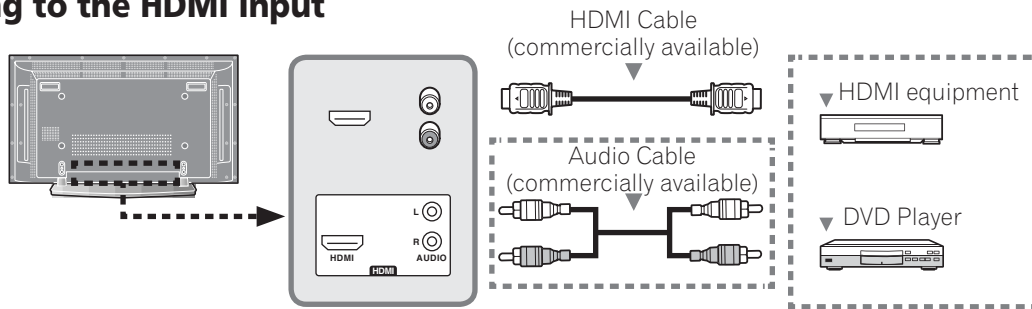

The digital video and audio signals can be input to the HDMI terminal. To use the HDMI terminal, activate the terminal and specify the types of video and audio signals to be received from the connected equipment. For the types of these signals, refer to the operation manual supplied with the connected equipment.

Input signal correlation table

1920*1080i@59.94/60Hz
720*480p@59.94/60Hz
1280*720p@59.94/60Hz
720(1440)*480i@59.94/60Hz

- 1 Connect the HDMI cable to the **HDMI** jack on the Plasma Display and to the DVD output jack on the required equipment.
- 2 When connecting with DVI jack, such as a DVD player, connect the audio cable to the **AUDIO INPUT-L/R** jacks on the Plasma Display and to the audio output jacks on the required equipment.
- 3 Turn the Plasma Display on, then press the **INPUT** button to select **HDMI**.

NOTE

- PC signals are not supported.
- If no image appears, specify another digital video signal type.
- For the digital video signal types to be specified, refer to the operation manual supplied with the connected equipment.

Connecting to the Monitor Output

Your Plasma Display can send out the audio/video signals to the external connector. You can also record from the Plasma Display to a second VCR or DVD recorder. For more details about recording, refer to the equipment's instructions.

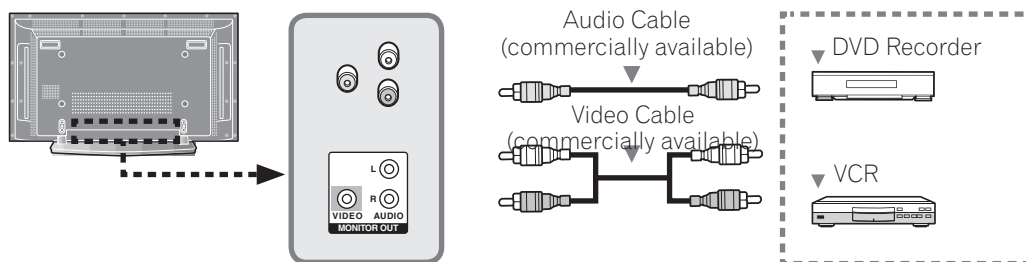

- 1 Connect the video cable to the **VIDEO (MONITOR OUT)** output jack on the Plasma Display and to the video input jack on the required equipment.
- 2 Connect the audio cable to the **AUDIO-L/R (MONITOR OUT)** output jacks on the Plasma Display and to the audio input jacks on the required equipment.

NOTE

- The MONITOR OUT terminals do not output the following signals:
 - 1 Video signals input from the COMPONENT VIDEO OUT terminal (1 and 2)
 - 2 Digital video and audio signals from the HDMI terminal (INPUT 3)
 - When watching images played back on a VCR or DVD recorder connected to the MONITOR OUT terminals, select an input source (e.g., TV channel reception) on the recording equipment other than external input sources. Selecting an external input source may result in distorted images or noise.

Connecting to the DIGITAL Audio Output

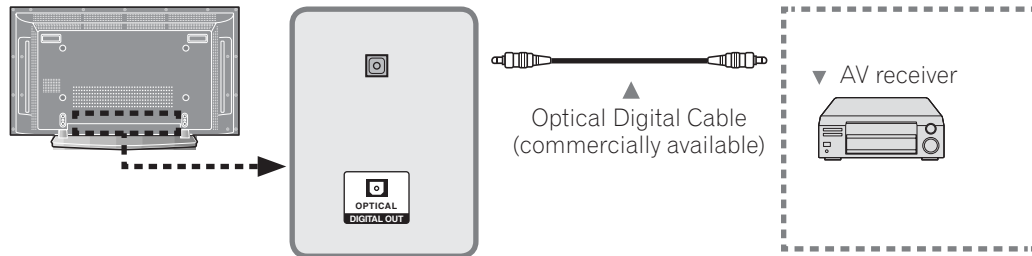



Connect the optical cable to the **DIGITAL OUT** terminal on the Plasma Display and to the optical input jack on the digital audio system.

NOTE

- When using the digital audio output terminal (optical), you need to make settings depending on your AV receiver. For more information, refer to the instruction manual supplied with the AV receiver.
- For details, see "Setting up External Digital Sound" on page 35.

Troubleshooting

Problem	Possible Solution
• No power.	<ul style="list-style-type: none"> • Make sure the Plasma Display is connected correctly. (See page 18.) • Is the power cord disconnected? (See page 18.) • Has the power been turned on? (See page 19.) • Check if you pressed TV  on the remote control unit. (See page 19.) If the STANDBY indicator on the Plasma Display lights up red, press TV .
• No picture or sound	<ul style="list-style-type: none"> • Check if the power cord is connected correctly. • Check that you have pressed the TV  on the remote control or the STANDBY/ON button on the Plasma Display. • Select an input source responding to that particular source. • Check the picture contrast and brightness settings. • Check the volume.
• Normal picture but no sound	<ul style="list-style-type: none"> • Check the volume. • Check whether the MUTING button on the remote control has been pressed.
• No picture or black and white picture	<ul style="list-style-type: none"> • Adjust the color settings. • Check that the correct broadcast system is selected.
• Sound and picture interference	<ul style="list-style-type: none"> • Try to identify the electrical appliance that is affecting the Plasma Display, then move it further away. • Plug the Plasma Display into a different wall outlet.
• Blurred or snowy picture, distorted sound	<ul style="list-style-type: none"> • Check the direction, location and connections of your aerial. Such interference often occurs due to the use of an indoor aerial.
• Remote control malfunctions	<ul style="list-style-type: none"> • Press the INPUT button to select the Plasma Display or an external device. • Replace the batteries in the remote control. • Install batteries ensuring that the <+> and - ends of the batteries are inserted correctly. • Check the angle and distance of the remote control to the Plasma Display. Make sure there are no obstacles between the remote control and the Plasma Display. • Check that the correct function button has been pressed. • Change the location of light sources or the direction of the Plasma Display to avoid glare.

The video program that you watch may be high definition (HD) or standard definition (SD). This Plasma Display is designed to scale to each type of definition properly. If the video program's definition type changes while a menu window is displayed on the screen (for example: HD→SD or SD→HD), the menu size may temporarily shrink or enlarge until the scaling is completed. This may happen, for example, when you switch between television and an external digital video recorder (D-VHS), or when your recorded program switches between different definition types, while the on-screen menu is being shown.

If this happens, the menu will return to its normal size after two to three seconds. This action is normal, and does not indicate a problem with your Plasma Display.

Specifications

Item		42" Plasma Display, Model: PDP-42A3HD/PDP-4214HD	
Number of Pixels		1024 × 768 pixels	
Audio Amplifier		10 W + 10 W (1 kHz, 10 %, 4 Ω)	
Surround System		SRS TruSurround XT	
Power Requirement		120 V AC, 60 Hz, 250 W (2.5 W Standby)	
Dimensions (with stand)		1235 (W) × 699 (H) × 252 (D) mm (45 ⁵ / ₈ (W) × 27 ¹ / ₂ (H) × 10 (D) inches)	
Weight (with stand)		40.5 kg (89.3 lbs.)	
Reception System (Digital)		ATSC Digital TV system	
Circuit type		8VSB demodulation	
Tuner		VHF 2–13ch, UHF 14–69ch	
Audio format		Dolby Digital	
Reception System (Analog)		American TV standard NTSC system	
Tuning System		FS	
Tuner		VHF/UHF	VHF 2–13ch, UHF 14–69ch
		CATV	1–125ch
Audio multiplex		BTSC system	
Terminals	Rear	DTV-ANTENNA IN	75 Ω UNBAL, F Type for DTV in
		ANTENNA/CABLE IN	75 Ω UNBAL, F Type for VHF/UHF/CATV in
		VIDEO 1	S-VIDEO in, VIDEO in, AUDIO in
		VIDEO 2	S-VIDEO in, VIDEO in, AUDIO in
		COMPONENT 1	COMPONENT VIDEO in, AUDIO in
		COMPONENT 2	COMPONENT VIDEO in, AUDIO in
		HDMI	HDMI in, AUDIO in
		MONITOR OUT	VIDEO out, AUDIO out
		DIGITAL OUT	OPTICAL out
		RS-232C	Service only
	Side	VIDEO 3	S-VIDEO in, VIDEO in, AUDIO in
OSD		English/French/Spanish	

- Design and specifications are subject to change without notice.

Trademarks

- **SRS**  is a trademark of SRS Labs, Inc.

TruSurround XT technology is incorporated under license from SRS Labs, Inc.

- Manufactured under license from Dolby Laboratories. "Dolby" and the double-D symbol are trademarks of Dolby Laboratories.
- HDMI, the HDMI logo and High-Definition Multimedia Interface are trademarks or registered trademarks of HDMI Licensing LLC.
- The names of the companies or institutions are trademarks or registered trademarks of the respective companies or institutions.



Printed on recycled paper
Imprimé sur papier recyclé
Impreso en papel reciclado

Should this product require service in the U.S.A. and you wish to locate the nearest Pioneer Authorized Independent Service Company, or if you wish to purchase replacement parts, operating instructions, service manuals, or accessories, please call the number shown below.

8 0 0 - 4 2 1 - 1 6 2 5

Please do not ship your product to Pioneer without first calling the Customer Support Division at the above listed number for assistance.

Pioneer Electronics (USA) Inc.
Customer Support Division
P.O. BOX 1760, Long Beach,
CA 90801-1760, U.S.A.

For warranty information please see the Limited Warranty sheet included with your product.

Should this product require service in Canada, please contact a Pioneer Canadian Authorized Dealer to locate the nearest Pioneer Authorized Service Company in Canada.
Alternatively, please contact the Customer Satisfaction Department at the following address:

Pioneer Electronics of Canada, Inc.
Customer Satisfaction Department
300 Allstate Parkway, Markham, Ontario L3R OP2
(905)479-4411
1(877)283-5901

For warranty information please see the Limited Warranty sheet included with your product.

Si ce produit doit être réparé au Canada, veuillez vous adresser à un distributeur autorisé Pioneer du Canada pour obtenir le nom du Centre de Service Autorisé Pioneer le plus près de chez-vous. Vous pouvez aussi contacter le Service à la clientèle de Pioneer:

Pioneer Électroniques du Canada, Inc.
Service à la clientèle
300, Allstate Parkway, Markham, Ontario L3R OP2
(905)479-4411
1(877)283-5901

Pour obtenir des renseignements sur la garantie, veuillez vous reporter au feuillet sur la garantie restreinte qui accompagne le produit.

S018D_enfr

Published by Pioneer Corporation.
Copyright © 2005 Pioneer Corporation.
All rights reserved.

PIONEER CORPORATION

4-1, Meguro 1-Chome, Meguro-ku, Tokyo 153-8654, Japan

PIONEER ELECTRONICS (USA) INC.

P.O. BOX 1540, Long Beach, California 90810-1540, U.S.A. TEL: (800) 421-1404

PIONEER ELECTRONICS OF CANADA, INC.

300 Allstate Parkway, Markham, Ontario L3R OP2, Canada TEL: 1-877-283-5901

PIONEER EUROPE NV

Haven 1087, Keetberglaan 1, B-9120 Melsele, Belgium TEL: 03/570.05.11

PIONEER ELECTRONICS ASIACENTRE PTE. LTD.

253 Alexandra Road, #04-01, Singapore 159936 TEL: 65-6472-7555

PIONEER ELECTRONICS AUSTRALIA PTY. LTD.

178-184 Boundary Road, Braeside, Victoria 3195, Australia, TEL: (03) 9586-6300

PIONEER ELECTRONICS DE MEXICO S.A. DE C.V.

Bldv.Manuel Avila Camacho 138 10 piso Col.Lomas de Chapultepec, Mexico,D.F. 11000 TEL: 55-9178-4270

K002_A_En

<04H00001>

Printed in Korea / Imprimé en Corée du sud <ARE1402-A>



Free Manuals Download Website

<http://myh66.com>

<http://usermanuals.us>

<http://www.somanuals.com>

<http://www.4manuals.cc>

<http://www.manual-lib.com>

<http://www.404manual.com>

<http://www.luxmanual.com>

<http://aubethermostatmanual.com>

Golf course search by state

<http://golfingnear.com>

Email search by domain

<http://emailbydomain.com>

Auto manuals search

<http://auto.somanuals.com>

TV manuals search

<http://tv.somanuals.com>